

# EFAPEL<sup>®</sup>

ELECTRICAL SOLUTIONS



SERIES

# LATINA



“Simple and inspiring solutions.”

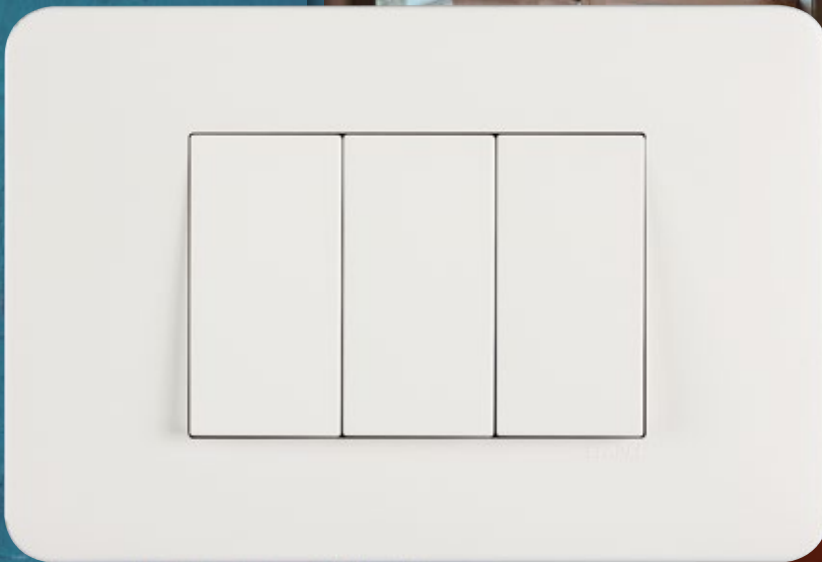

“One design two, matrices.”



“Wide range of colors and modularity.”

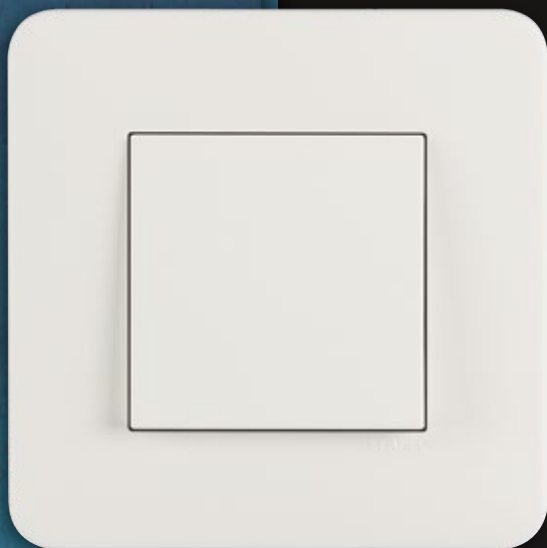

**TABLE OF CONTENTS**

**PAGE**

- INTRODUCTION 4
- LATINA FINISHINGS 12
- MEC Q45 MECHANISMS
  - CONTROL DEVICES 14
  - DIMMERS 17
  - MOTION DETECTORS 18
  - ORIENTATION AND LIGHT INDICATORS 18
  - TEMPERATURE CONTROL 19
  - ELECTRIC SHUTTERS CONTROLLERS 19
  - RELAYS FOR ELECTRIC SHUTTERS 20
  - DATA, VOICE AND IMAGE SOCKETS 20
  - MODULES WITH CONNECTORS OF DATA, VOICE AND IMAGE 21
  - MODULES FOR CONNECTORS OF DATA, VOICE AND IMAGE 21
  - CONNECTORS FOR MODULES OF DATA, VOICE AND IMAGE 21
  - MODULES WITH COUPLERS FOR FIBRE OPTIC CONNECTORS 22
  - RADIO, TELEVISION AND SATELLITE SOCKETS 22
  - CABLE OUTPUTS 22
  - USB POWER SOCKETS 23
  - POWER SOCKETS 23
  - MEC Q45 ACCESSORIES 25
- SUPPORT FRAMES 26
- SURFACE BOXES 26
- LATINA FRAMES AND SUPPORT FRAMES
  - EUROPEAN MATRIX 27
  - ITALIAN MATRIX 28
- TECHNICAL INFORMATION 31





- BASE
- AQUARELLA



- CROMA  
with metal border



- LYRA
- LIGNA
- METALLUM

# EUROPEAN MATRIX

LATINA



*for European type installations*

# ITALIAN MATRIX

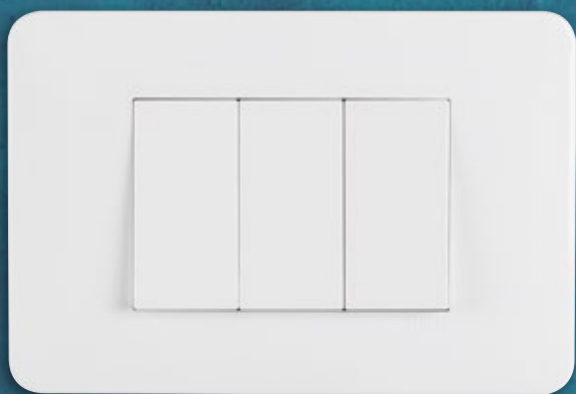

*for Italian type installations*





- BASE
- AQUARELLA



- CRYSTAL  
*frame in Crystal*



- LYRA
- LIGNA
- METALLUM

# EUROPEAN MATRIX

LATINA

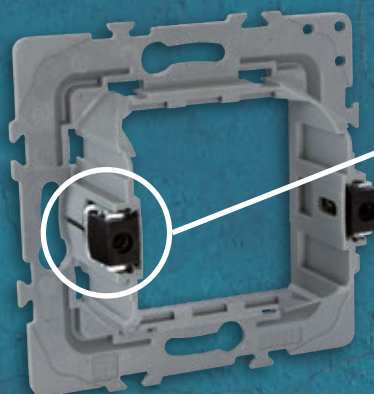
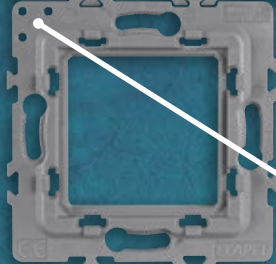
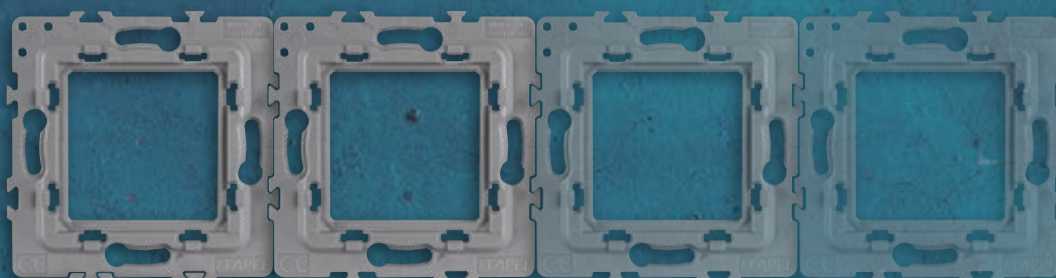

**SUPPORT FRAMES WITH CLAWS**  
(REF. 42994)

Support Frames with or without claws

# ITALIAN MATRIX

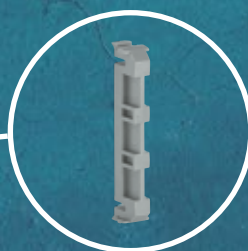

**90° POSITIONER**  
To adapt for mounting 1 and 2 modules.  
(REF. 41992)

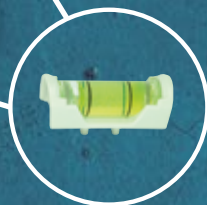

**SPIRIT**  
mounting level.  
(REF. 81989)

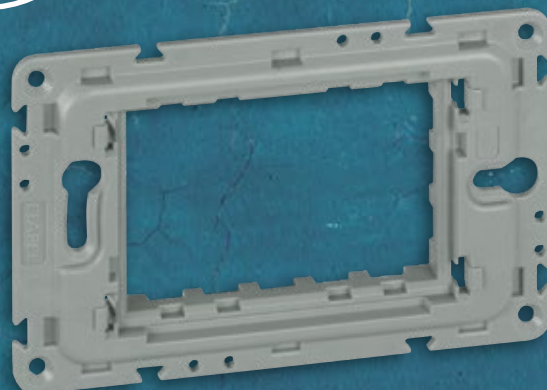



”The **solution** that **completes** your home.”



**CHARACTERISTICS**

---

LATINA inspires the creation of modern and unique spaces, with a perfect combination between a wide range of materials and colours that complement each other in modern and unique environments. The Base range, offers a cost-effective piece with a beautiful and simple design.

**SUPPORT FRAMES**

---



**MECHANISM**

---



**FRAMES**

---



LATINA

ITALIAN MATRIX 

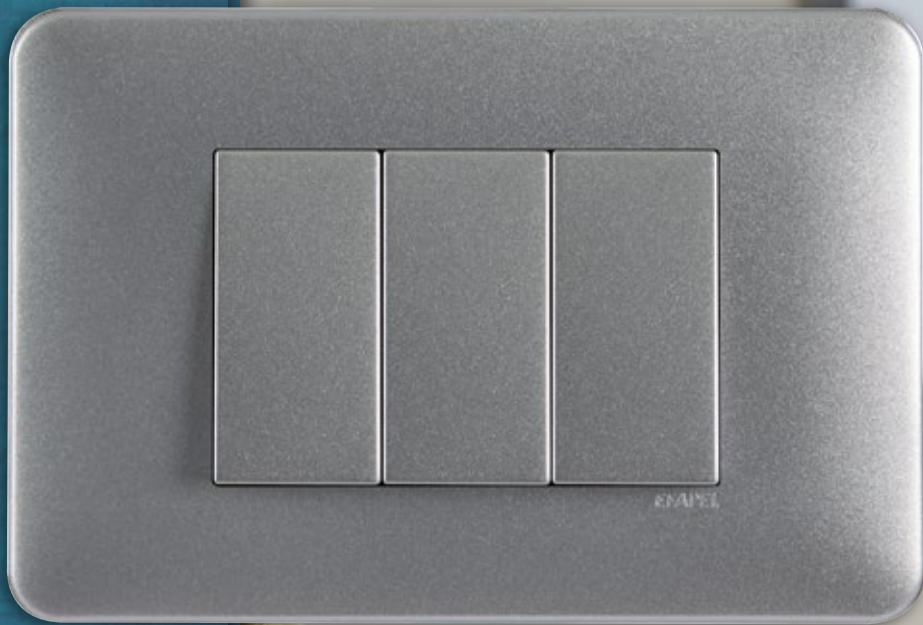

”The **detail** on your **decor.**”

EFAPEL



## CHARACTERISTICS

---

The various frames and their different materials provide the most luxurious ranges of LATINA with a special touch, without losing their balance, character and simplicity.  
The detail which will be a statement on your decor.

### SUPPORT FRAMES

---

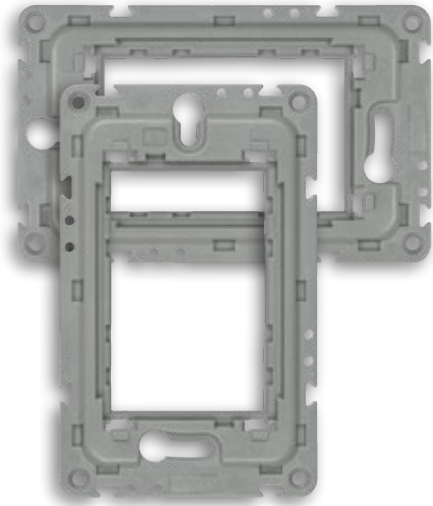

### MECHANISM

---



### FRAMES

---

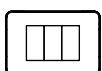

### BASE

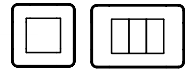

**BR**  
White

### AQUARELLA



**BM**  
Matte White

**AL**  
Aluminium

**PM**  
Matte Black

### LYRA



**CE**  
Beige

**AZ**  
Blue

**AM**  
Yellow

**VR**  
Green

**LR**  
Orange

**RJ**  
Red

### LIGNA



**RO**  
Oak

**FA**  
Beech

**MG**  
Mahogany

**WG**  
Wenge

# FINISHINGS

## METALLUM



**LU**  
Aluminium

**RB**  
Ruddy

**CO**  
Copper

**OR**  
Gold

**CR**  
Chrome

## CROMA



**BH**  
Matte White / Chrome

**AH**  
Aluminium / Chrome

**PH**  
Matte Black / Chrome

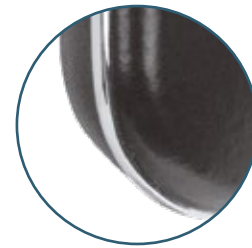

**Detail** of the metallic border in the CROMA frames.

## CRYSTAL<sup>(\*)</sup>

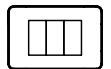

**CB**  
Crystal / Matte White

**CA**  
Crystal / Aluminium

**CK**  
Crystal / Matte Black



















**(\*) - Only available for the Italian Matrix, in 3 and 3+3 modules.**































**EB**  
Black Crystal / Matte White

**EA**  
Black Crystal / Aluminium













**EP**  
Black Crystal / Matte Black

CONTROL DEVICES		Ref.	Color
	<b>Single Pole Switch - 2 Modules</b> 10AX - 250V~	45011 S	BR BM PM AL
	<b>Single Pole Switch - 1 Module</b> 10AX - 250V~	45010 S	
	<b>Single Pole Switch with Orienting Light - 2 Modules</b> 10AX - 250V~ ■ To control electronic energy-saving lamps, we recommend using 0,15µF 275V~ capacitors connected in parallel with the load to prevent flickering.	45012 S	BR BM PM AL
	<b>Single Pole Switch with Orienting Light - 1 Module</b> 10AX - 250V~ ■ To control electronic energy-saving lamps, we recommend using 0,15µF 275V~ capacitors connected in parallel with the load to prevent flickering.	45015 S	
	<b>Single Pole Switch with Pilot Lamp - 2 Modules</b> 10AX - 250V~	45013 S	BR BM PM AL
	<b>Single Pole Switch with Pilot Lamp - 1 Module</b> 10AX - 250V~	45016 S	
	<b>Double Pole Switch - 2 Modules</b> 10AX - 250V~	45021 S	BR BM PM AL
	<b>Double Pole Switch - 1 Module</b> 10AX - 250V~	45020 S	
	<b>Double Pole Switch with Pilot Lamp - 2 Modules</b> 10AX - 250V~	45023 S	BR BM PM AL
	<b>Double Pole Switch with Pilot Lamp - 1 Module</b> 10AX - 250V~	45026 S	
	<b>1 Circuit Digital Timer Switch - 2 Modules</b> ■ Power: 230V~ - 50/60Hz. ■ Cut-off power: 16A (cosφ =1). ■ Functions: ON, OFF and PULSE. ■ <a href="#">Technical Data Sheet - page 36.</a>	 45041 S	BR BM PM AL
	<b>2 Circuit Digital Timer Switch - 2 Modules</b> ■ Power: 230V~ - 50/60Hz. ■ Cut-off power: 6A + 6A (cosφ =1). ■ Functions: ON, OFF and PULSE. ■ <a href="#">Technical Data Sheet - page 36.</a>	 45042 S	
	<b>Card-System Timer Switch - 2 Modules</b> ■ Power: 100-240V~, 50/60Hz. ■ Maximum load: 16A (cosφ =1). ■ Adjustable disconnection delay: 0-60 seconds. ■ <a href="#">Technical Data Sheet - page 37.</a>	 45033 S	BR BM PM AL
	<b>Timer Switch - 2 Modules</b> ■ Power: 100-240V~, 50/60Hz. ■ Maximum load: 16A (cosφ =1). ■ Adjustable disconnection delay: 5 seconds to 15 minutes. ■ <a href="#">Technical Data Sheet - page 38.</a>	 45040 S	BR BM PM AL

CONTROL DEVICES		Ref.	Color
	<b>Two-Circuits Switch - 2 Modules</b> 10AX - 250V~	45061 S	BR BM PM AL
	<b>2-Way Switch - 2 Modules</b> 10AX - 250V~	45071 S	BR BM PM AL
	<b>2-Way Switch - 1 Module</b> 10AX - 250V~	45070 S	
	<b>2-Way Switch with Orienting Light - 2 Modules</b> 10AX - 250V~ ■ To control electronic energy-saving lamps, we recommend using 0,15µF 275V~ capacitors connected in parallel with the load to prevent flickering.	45072 S	BR BM PM AL
	<b>2-Way Switch with Orienting Light - 1 Module</b> 10AX - 250V~ ■ To control electronic energy-saving lamps, we recommend using 0,15µF 275V~ capacitors connected in parallel with the load to prevent flickering.	45074 S	
	<b>2-Way Switch with Pilot Lamp - 2 Modules</b> 10AX - 250V~	45073 S	BR BM PM AL
	<b>2-Way Switch with Pilot Lamp - 1 Module</b> 10AX - 250V~	45076 S	
	<b>Double Pole 2-Way Switch - 2 Modules</b> 10AX - 250V~	45077 S	BR BM PM AL
	<b>Intermediate Switch - 2 Modules</b> 10AX - 250V~	45051 S	BR BM PM AL
	<b>Intermediate Switch - 1 Module</b> 10AX - 250V~	45050 S	
	<b>Intermediate Switch with Orienting Light - 2 Modules</b> 10AX - 250V~ ■ To control electronic energy-saving lamps, we recommend using 0,15µF 275V~ capacitors connected in parallel with the load to prevent flickering.	45052 S	BR BM PM AL
	<b>Intermediate Switch with Orienting Light - 1 Module</b> 10AX - 250V~ ■ To control electronic energy-saving lamps, we recommend using 0,15µF 275V~ capacitors connected in parallel with the load to prevent flickering.	45053 S	
	<b>Rocker Push-button Switch - 2 Modules</b> 10A - 250V~	45151 S	BR BM PM AL
	<b>Rocker Push-button Switch - 1 Module</b> 10A - 250V~	45161 S	













CONTROL DEVICES		Ref.	Color
	<b>Rocker Push-button Switch (NO+NC) - 2 Modules</b> 10A - 250V~ ■ Normally Open contact (NO) + Normally Closed contact (NC).	45150 S	BR BM PM AL
	<b>Rocker Push-button Switch (NO+NC) - 1 Module</b> 10A - 250V~ ■ Normally Open contact (NO) + Normally Closed contact (NC).	45166 S	
	<b>Rocker Push-button Switch with Bell Symbol - 2 Modules</b> 10A - 250V~	45177 S	BR BM PM AL
	<b>Rocker Push-button Switch with Bell Symbol - 1 Module</b> 10A - 250V~	45167 S	
	<b>Rocker Push-button Switch with Light Symbol - 2 Modules</b> 10A - 250V~	45179 S	
	<b>Rocker Push-button Switch with Light Symbol - 1 Module</b> 10A - 250V~	45169 S	
	<b>Rocker Push-button Switch with Orienting Light (250V~) - 2 Modules</b> 10A - 250V~	45152 S	BR BM PM AL
	<b>Rocker Push-button Switch with Orienting Light (250V~) - 1 Module</b> 10A - 250V~	45160 S	
	<b>Rocker Push-button Switch with Orienting Light (12V) - 2 Modules</b> 6A - 12V	45162 S	BR BM PM AL
	<b>Rocker Push-button Switch with Orienting Light (12V) - 1 Module</b> 6A - 12V	45163 S	
	<b>Rocker Switch with Independent Pilot Lamp (250V~) - 2 Modules</b> 10A - 250V~	45154 S	BR BM PM AL
	<b>Rocker Switch with Independent Pilot Lamp (250V~) - 1 Module</b> 10A - 250V~	45153 S	
	<b>Rocker Switch with Independent Pilot Lamp (12V) - 2 Modules</b> 6A - 12V	45158 S	BR BM PM AL
	<b>Rocker Switch with Independent Pilot Lamp (12V) - 1 Module</b> 6A - 12V	45157 S	
	<b>Rocker Push-button Switch with Orienting Light with Lamp Symbol - 2 Modules</b> 10A - 250V~	45172 S	BR BM PM AL
	<b>Rocker Push-button Switch with Orienting Light with Lamp Symbol - 1 Module</b> 10A - 250V~	45171 S	









CONTROL DEVICES		Ref.	Color
	<b>Double Rocker Push-button Switch - 2 Modules</b> 10A - 250V~	45156 S	BR BM PM AL
	<b>Rocker Push-button / 2-Way Switch - 2 Modules</b> 10AX - 250V~	45159 S	BR BM PM AL
	<b>4-Gang Electronic Press-Button (Very Low Voltage) - 2 Modules</b> 12V~ - 50mA / 32V~ - 18mA <a href="#">Technical Data Sheet - page 39.</a>	45164 S	BR BM PM AL
 	<b>Rotary Switch - 2 Modules</b> 10AX - 250V~	 45302 S	BR BM PM AL
 	<b>Rotary 2-Way Switch - 2 Modules</b> 10AX - 250V~ ■ ON - OFF - ON.	 45301 S	BR BM PM AL
 	<b>Key Lock 2-Way Switch - 2 Modules</b> 10AX - 250V~ ■ ON - OFF - ON. ■ Key can be removed in all three positions.	 45352 S	BR BM PM AL
 	<b>Key Lock Push-button Switch - 2 Modules</b> 10A - 250V~ ■ ON - OFF - ON. ■ Key can only be removed in OFF position.	 45351 S	BR BM PM AL
	<b>2-Way Pull Cord Switch - 2 Modules</b> 10AX - 250V~ ■ Normally Open contact (NO) + Normally Closed contact (NC).	 45092 S	BR BM PM AL
 	<b>Push-button Pull Cord Switch (NO+NC) - 2 Modules</b> 10A - 250V~ ■ Normally Open contact (NO) + Normally Closed contact (NC).	 45090 S	BR BM PM AL
DIMMERS			
	<b>RLC Rotary Dimmer - 2 Modules</b> ■ Power: 100-240V~ - 50/60Hz. ■ Compatible with RLC circuits (R, RL and RC). ■ No need for a neutral line (directly replaces a Single Pole Switch). <a href="#">Technical Data Sheet - page 40.</a>	 45216 S	BR BM PM AL
	<b>RLC Dimmer Press Switch - 2 Modules</b> ■ Power: 100-240V~ - 50/60Hz. ■ Compatible with RLC circuits (R, RL and RC). ■ No need for a neutral line (directly replaces a Single Pole Switch). ■ Possibility to pre-set lighting: Light, Indicator, always ON and OFF. <a href="#">Technical Data Sheet - page 41.</a>	 45218 S	BR BM PM AL

 - Screw terminals connection





 - Products with this symbol save energy and contribute to the building's energy efficiency.









MOTION DETECTORS		Ref.	Color
	<b>Motion Detector - Wall Installation 1000W - 2 Modules</b> <ul style="list-style-type: none"> <li>■ Wall installation with front push button.</li> <li>■ Power: 100-240V~ - 50/60Hz.</li> <li>■ Maximum load: 1000W.</li> <li>■ Regulation of light sensitivity and time adjustment.</li> <li>■ Range: 9 metres. Detection angle: 160°.</li> <li>■ Potential-free contact, relay output, compatible with any load type.</li> </ul> <a href="#">Technical Data Sheet - page 42.</a>	 45403 S	BR BM PM AL
	<b>Motion Detector - Wall Installation 400W - 2 Modules</b> <ul style="list-style-type: none"> <li>■ Wall installation with front push button.</li> <li>■ Power: 100-240V~ - 50/60Hz.</li> <li>■ Maximum load: 400W.</li> <li>■ Regulation of light sensitivity and time adjustment.</li> <li>■ Range: 9 metres. Detection angle: 160°.</li> <li>■ Potential-free contact, relay output, compatible with any load type.</li> </ul> <a href="#">Technical Data Sheet - page 42.</a>	 45404 S	
	<b>Motion Detector 1000W - 2 Modules</b> <ul style="list-style-type: none"> <li>■ Power: 100-240V~ - 50/60Hz.</li> <li>■ Maximum load: 1000W.</li> <li>■ Regulation of light sensitivity and time adjustment.</li> <li>■ Range: 12 metres. Detection angle: 160°.</li> <li>■ Potential-free contact, relay output, compatible with any load type.</li> </ul> <a href="#">Technical Data Sheet - page 43.</a>	 45401 S	BR BM PM AL
	<b>Motion Detector 400W - 2 Modules</b> <ul style="list-style-type: none"> <li>■ Power: 100-240V~ - 50/60Hz.</li> <li>■ Maximum load: 400W.</li> <li>■ Regulation of light sensitivity and time adjustment.</li> <li>■ Range: 12 metres. Detection angle: 160°.</li> <li>■ Potential-free contact, relay output, compatible with any load type.</li> </ul> <a href="#">Technical Data Sheet - page 43.</a>	 45402 S	
ORIENTATION AND LIGHT INDICATORS		Ref.	Color
 	<b>Light Indicator - 2 Modules</b> <ul style="list-style-type: none"> <li>■ Power: 230V~ - 50/60Hz.</li> <li>■ LED, Color Temperature 4000K.</li> </ul> For colored versions select the frontal covering. <a href="#">Technical Data Sheet - page 44.</a>	45361 S	IC VD LR VM
	 		
	<b>White Orientation Light - 2 Modules</b> <ul style="list-style-type: none"> <li>■ Power: 230V~ - 50/60Hz.</li> <li>■ LED, Color Temperature 4000K.</li> </ul> <a href="#">Technical Data Sheet - page 45.</a>	45388 S	BR BM PM AL
	<b>White Orientation Light with Battery - 2 Modules</b> <ul style="list-style-type: none"> <li>■ Power: 230V~ - 50/60Hz.</li> <li>■ Charging time: 36h / Autonomy: 1h.</li> <li>■ LED, Color Temperature 4000K.</li> </ul> <a href="#">Technical Data Sheet - page 45.</a>	45389 S	
	<b>Electronic Buzzer - 1 Module</b> <ul style="list-style-type: none"> <li>■ Power: 100-240V - 50/60Hz.</li> <li>■ Type D sound signal, 80dB a 1m.</li> </ul> <a href="#">Technical Data Sheet - page 46.</a>	45369 S	BR BM PM AL



## TEMPERATURE CONTROL





	Ref.	Color
 <p><b>Rotary Thermostat - 2 Modules</b></p> <ul style="list-style-type: none"> <li>■ Power: 100-240V~ - 50/60Hz.</li> <li>■ Maximum Load: 16A (cosφ = 1).</li> <li>■ Temperature adjustment: 5 °C to 30 °C.</li> <li>■ Temperature reading range: -9 °C to 35 °C.</li> <li>■ System controls: Heating and/or Cooling.</li> <li>■ Floor Probe connection possible (Ref. 81950), with automatic detection (for Protection only).</li> <li>■ Antifreeze Protection (Heating) and Thermal Protection (Cooling).</li> </ul> <p> <a href="#">Technical Data Sheet - page 47.</a></p>	45234 S	BR BM PM AL
 <p><b>Multifunctional Chronothermostat - 2 Modules</b></p> <ul style="list-style-type: none"> <li>■ Power: 100-240V~ - 50/60Hz.</li> <li>■ Maximum Load: 16A (cosφ = 1).</li> <li>■ Allows daily / weekly programming.</li> <li>■ Temperature control precision: 0.5 °C.</li> <li>■ Temperature reading range: -9 °C to 35 °C.</li> <li>■ System controls: Heating and/or Cooling.</li> <li>■ Floor Probe connection possible (Ref. 81950), with automatic detection.</li> <li>■ Temperature reading: Ambient or Temperature Sensor or both.</li> <li>■ Compatible with electrical or hydraulic systems.</li> <li>■ Antifreeze Protection (Heating) and Thermal Protection (Cooling).</li> </ul> <p> <a href="#">Technical Data Sheet - page 48.</a></p>	45235 S	BR BM PM AL
 <p><b>Multifunctional Thermostat - 2 Modules</b></p> <ul style="list-style-type: none"> <li>■ Power: 100-240V~ - 50/60Hz.</li> <li>■ Maximum Load: 16A (cosφ = 1).</li> <li>■ Temperature control precision: 0.5 °C.</li> <li>■ Temperature reading range: -9 °C to 35 °C.</li> <li>■ System controls: Heating and/or Cooling.</li> <li>■ Floor Probe connection possible (Ref. 81950), with automatic detection.</li> <li>■ Temperature reading: Ambient or Temperature Sensor or both.</li> <li>■ Possibility of remote control with Multifunctions IR Remote Control Transmitter (Ref. 81900).</li> <li>■ Compatible with electrical or hydraulic systems.</li> <li>■ Antifreeze Protection (Heating) and Thermal Protection (Cooling).</li> </ul> <p> <a href="#">Technical Data Sheet - page 49.</a></p>	45236 S	BR BM PM AL
 <p><b>Floor Probe for Thermostat and Chronothermostat</b></p> <ul style="list-style-type: none"> <li>■ Length: 4m.</li> <li>■ Temperature range: -10 ° to 50 °C.</li> <li>■ IP67.</li> <li>■ NTC 12K/25°C.</li> </ul>	81950	—













## ELECTRIC SHUTTERS CONTROLLERS



	Ref.	Color
 <p><b>Electric Shutters Switch - 2 Modules</b></p> <p>10A - 250V~</p> <ul style="list-style-type: none"> <li>■ Operates as a switch. Mechanic and electric protection against two simultaneous commands.</li> <li>■ Pressing one button automatically releases the other.</li> </ul>	45293 S	BR BM PM AL
 <p><b>Electric Shutters Switch with Mechanical Blockage - 2 Modules</b></p> <p>10A - 250V~</p> <ul style="list-style-type: none"> <li>■ Operates as a switch. Mechanic and electric protection against two simultaneous commands.</li> <li>■ You must "STOP" one operation before beginning another.</li> </ul>	45295 S	
 <p><b>Double Push-button for Electric Shutters - 2 Modules</b></p> <p>10A - 250V~</p> <ul style="list-style-type: none"> <li>■ Operates as Rocker push-button. Electrical protection against two simultaneous commands.</li> </ul>	45281 S	
 <p><b>Double Push-button Switch for Electric Shutters Control for Multiple Points - 2 Modules</b></p> <p>10A - 250V~</p> <ul style="list-style-type: none"> <li>■ Operates as Rocker push-button. Electrical protection against two simultaneous commands.</li> <li>■ Allows electric shutters to be controlled from several points.</li> <li>■ Applicable with Electric Shutter Control Relay (Ref. 81511).</li> </ul>	45283 S	











ELECTRIC SHUTTERS CONTROLLERS		Ref.	Color
	<b>Rotary Push-Button for Electric Shutters - 2 Modules</b> 10A - 250V~ ■ ON - OFF - ON.	 45303 S	BR BM PM AL
	<b>Rotary 2-Way Switch for Electric Shutters - 2 Modules</b> 10A - 250V~ ■ ON - OFF - ON.	 45305 S	
	<b>General Control Module with IR Sensor for Electric Shutters - 2 Modules</b> ■ Power: 100-240V~ - 50/60Hz. ■ Cut-off power: 5A (cosφ = 1). ■ Possibility of remote control with Multifunctions IR Remote Control Transmitter (Ref. 81900). ■ 2 Programmable functions (Open/Close). ■ "Standby" feature. <a href="#">■ Technical Data Sheet - page 50.</a>	 45311 S	BR BM PM AL
	<b>Local Control Module with IR Sensor for Electric Shutters - 2 Modules</b> ■ Power: 100-240V~ - 50/60Hz. ■ Cut-off power: 5A (cosφ = 1). ■ Possibility of remote control with Multifunctions IR Remote Control Transmitter (Ref. 81900). <a href="#">■ Technical Data Sheet - page 50.</a>	 45312 S	





RELAYS FOR ELECTRIC SHUTTERS		Ref.	Color
	<b>Automatic Relay for Electric Shutter Control</b> ■ Power: 230V~ - 50Hz. ■ Cut-off power: 6A. ■ Timed. ■ Can be used with Double Rocker Buttons and Double Electric Shutter Buttons. <a href="#">■ Technical Data Sheet - page 52.</a>	81512	—
	<b>Push Relay for Electric Shutter Control</b> ■ Power: 230V~ - 50Hz. ■ Cut-off power: 6A. ■ Non-timed. ■ Can only be connected locally with Double Push-Button Switch (Ref. 45283 S). ■ For centralised control of the installation, remotely associate with the Double Push-Button Switch (Ref. 45283 S). <a href="#">■ Technical Data Sheet - page 52.</a>	81511	—

DATA, VOICE AND IMAGE SOCKETS		Ref.	Color
	<b>USB Data Socket - 1 Module</b> ■ For data transfer via USB connection. ■ Maximum speed: 12 Mb/s. <a href="#">■ Technical Data Sheet - page 55.</a>	45437 S	BR BM PM AL
	<b>HDMI Socket with Connector - 1 Module</b> ■ High definition audio and video data passing socket between any transmitter (computer, DVD, ...) and a terminal (TV, LCD, Video projector, ...). ■ Maximum resolution: 1080p. <a href="#">■ Technical Data Sheet - page 54.</a>	45435 S	
	<b>HDMI Socket with Screw Connection - 2 Modules</b> ■ High definition audio and video data passing socket between any transmitter (computer, DVD, ...) and a terminal (TV, LCD, Video projector, ...). ■ Maximum resolution: 1080p. <a href="#">■ Technical Data Sheet - page 54.</a>	45436 S	BR BM PM AL
	<b>Female HD15 VGA Socket - 2 Modules</b> ■ Video data passing socket between any transmitter (computer, DVD, ...) and a terminal (TV, LCD, Video projector, ...). <a href="#">■ Technical Data Sheet - page 55.</a>	45430 S	
	<b>Female RCA Socket 3 Outputs - 1 Module</b> ■ Audio and video data passing socket between any transmitter (computer, DVD, ...) and a terminal (TV, LCD, Video projector, ...). <a href="#">■ Technical Data Sheet - page 55.</a>	45580 S	



MODULES WITH CONNECTORS OF DATA, VOICE AND IMAGE				Ref.	Color
	Module with <b>RJ45 Connector Cat. 6A UTP</b> (500 MHz) - 1 Module 		45440 S	BR BM PM AL	
	Module with <b>RJ45 Connector Cat. 6 UTP</b> (250 MHz) - 1 Module 		45978 S		
	Module with <b>RJ45 Connector Cat. 5e UTP</b> (100 MHz) - 1 Module		45975 S		
	Module with <b>RJ11 Connector Cat. 3</b> - 1 Module		45972 S		
	Module with <b>RJ45 Connector Cat. 6 STP</b> (250 MHz) - 1 Module		45988 S		
	Module with <b>RJ45 Connector Cat. 5e STP</b> (100 MHz) - 1 Module		45985 S		
	Module with <b>Coaxial F-Type Connector</b> - 1 Module		45979 S	BR BM PM AL	
	Module with <b>Male IEC / F-Type Connector</b> - 1 Module		45982 S		
	Module with <b>Female IEC / F-Type Connector</b> - 1 Module		45983 S		





MODULES FOR CONNECTORS OF DATA, VOICE AND IMAGE				Ref.	Color
	Module for <b>2 RJ45 Connectors</b> - 2 Modules (Connectors not included) ■ Suitable for Keystone RJ connectors.		45971 S	BR BM PM AL	
	Module for <b>1 RJ45 Connector</b> - 2 Modules (Connectors not included) ■ Suitable for Keystone RJ connectors.		45976 S		
	Module for <b>1 RJ45 Connector</b> - 1 Module (Connectors not included) ■ Suitable for Keystone RJ connectors.		45977 S		

CONNECTORS FOR MODULES OF DATA, VOICE AND IMAGE				Ref.	Color
	<b>RJ45 Connector Cat. 6A UTP</b> (500 MHz)  <a href="#">Technical Data Sheet - page 56.</a>		82021	—	
	<b>RJ45 Connector Cat. 6 UTP</b> (250 MHz)  <a href="#">Technical Data Sheet - page 56.</a>		21978		
	<b>RJ45 Connector Cat. 6 UTP</b> - Rack Assembly (250 MHz)		82020	—	
	<b>RJ45 Connector Cat. 6 STP</b> (250 MHz)		21988		
	<b>RJ45 Connector Cat. 5e UTP</b> (100 MHz)		21975	—	
	<b>RJ45 Connector Cat. 5e STP</b> (100 MHz)		21985		
	<b>RJ11 Connector Cat. 3</b>		21972	—	

MODULES WITH COUPLERS FOR FIBRE OPTIC CONNECTORS		Ref.	Color
	Module with Coupler for <b>SC APC Duplex Fibre Optic Connector - 2 Modules</b>	45448 S	BR BM PM AL
	Module with Coupler for <b>SC APC Simplex Fibre Optic Connector - 2 Modules</b>	45447 S	
	Module with Coupler for <b>LC Duplex Fibre Optic Connector - 2 Modules</b>	45449 S	
	Protective Cover for <b>SC APC Simplex Fibre Optic Coupler</b>	82970	—
	Protective Cover for <b>SC APC Duplex Fibre Optic Coupler</b>	82971	

**RADIO, TELEVISION AND SATELLITE SOCKETS**



STAR CONNECTION		Ref.	Color
	<b>R - TV - SAT (Star) Socket - 2 Modules</b> <ul style="list-style-type: none"> <li>4 - 862 MHz: &lt; 2dB.</li> <li>950 - 2400 MHz: &lt; 3dB.</li> <li>Current flow: 500mA (DC).</li> </ul> <a href="#">Technical Data Sheet - page 57.</a>	45543 S	BR BM PM AL
	<b>R - TV (Star) Socket - 2 Modules</b> <ul style="list-style-type: none"> <li>4 - 82 MHz: &lt; 1dB.</li> <li>84 - 108 MHz: &lt; 2dB.</li> <li>112 - 1000 MHz: &lt; 1dB.</li> </ul> <a href="#">Technical Data Sheet - page 57.</a>	45533 S	

SERIES CONNECTION		Ref.	Color
	<b>R - TV - SAT (Terminal) Socket - 2 Modules</b> <ul style="list-style-type: none"> <li>4 - 446 MHz: &lt; 6dB.</li> <li>470 - 862 MHz: &lt; 9dB.</li> <li>950 - 2400 MHz: &lt; 6dB.</li> <li>Current flow: 500mA (DC).</li> </ul> <a href="#">Technical Data Sheet - page 57.</a>	45555 S	BR BM PM AL
	<b>R - TV - SAT (Passage) Socket - 2 Modules</b> <ul style="list-style-type: none"> <li>4 - 862 MHz: &lt; 10dB.</li> <li>950 - 2150 MHz: &lt; 11dB.</li> <li>2150 - 2400 MHz: &lt; 9dB.</li> <li>Current flow: 500mA (DC).</li> <li>Insertion losses: 3dB.</li> </ul> <a href="#">Technical Data Sheet - page 57.</a>	45565 S	
	<b>R - TV (Terminal) Socket - 2 Modules</b> <ul style="list-style-type: none"> <li>4 - 82 MHz: &lt; 6dB.</li> <li>84 - 108 MHz: &lt; 8dB.</li> <li>112 - 1000 MHz: &lt; 7dB.</li> </ul> <a href="#">Technical Data Sheet - page 57.</a>	45554 S	
	<b>R - TV (Passage) Socket - 2 Modules</b> <ul style="list-style-type: none"> <li>4 - 1000 MHz: &lt; 9dB.</li> <li>Insertion losses: 2dB.</li> </ul> <a href="#">Technical Data Sheet - page 57.</a>	45564 S	



















**CABLE OUTPUTS**



























CABLE OUTPUTS		Ref.	Color
	<b>Cable Output - 2 Modules</b> <ul style="list-style-type: none"> <li>With cable fixation system.</li> </ul>	45170 S	BR BM PM AL
	<b>3-Cable Terminals Output - 2 Modules</b> <ul style="list-style-type: none"> <li>With cable fixation system.</li> <li>3x2,5mm<sup>2</sup> / 450V~.</li> </ul>	45173 S	
	<b>4-Cable Terminals Output - 2 Modules</b> <ul style="list-style-type: none"> <li>With cable fixation system.</li> <li>4x1,5mm<sup>2</sup> / 450V~.</li> </ul>	45174 S	

## USB POWER SOCKETS























	Ref.	Color
 <p><b>Double USB Charger Type A with 20° Outputs - 2 Modules</b></p> <ul style="list-style-type: none"> <li>■ Power: 100-240V~ - 50/60Hz.</li> <li>■ Maximum output current: 5V= - 2.4A.</li> <li>■ Two Type A USB outputs.</li> </ul> <p><a href="#">Technical Data Sheet - page 59.</a></p>	45384 S	BR BM PM AL
 <p><b>Double USB Charger Type A - 2 Modules</b></p> <ul style="list-style-type: none"> <li>■ Power: 100-240V~ - 50/60Hz.</li> <li>■ Maximum output current: 5V= - 2.1A</li> <li>■ Two Type A USB outputs.</li> </ul> <p><a href="#">Technical Data Sheet - page 59.</a></p>	45439 S	BR
 <p><b>USB Charger Type A - 1 Module</b></p> <ul style="list-style-type: none"> <li>■ Power: 100-240V~ - 50/60Hz.</li> <li>■ Maximum output current: 5V= - 1.5A</li> <li>■ Type A USB output.</li> </ul> <p><a href="#">Technical Data Sheet - page 59.</a></p>	45383 S	BR BM PM AL

## POWER SOCKETS







	Ref.	Color
<b>SCHUKO SOCKETS</b>		
 <p><b>Schuko Shutter Socket with Screwless Terminals - 2 Modules</b> 16A - 250V~</p> 	45126 S	BR BM PM AL LR VD VM
 <p><b>Schuko Shutter Socket with Screwless Terminals and Hinged Lid - 2 Modules</b> 16A - 250V~</p> 	45127 S	
 <p><b>Schuko Shutter Socket - 2 Modules</b> 16A - 250V~</p>  	45129 S	
 <p><b>Schuko Shutter Socket with Hinged Lid - 2 Modules</b> 16A - 250V~</p>  	45128 S	
 <p><b>45° Schuko Shutter Socket - 2 Modules</b> 16A - 250V~</p> <ul style="list-style-type: none"> <li>■ Inclined 45°.</li> </ul>  	45132 S	
 <p><b>45° Schuko Socket - 2 Modules</b> 16A - 250V~</p> <ul style="list-style-type: none"> <li>■ Inclined 45°.</li> </ul> 	45131 S	
 <p><b>45° Schuko Socket with Blockage - 2 Modules</b> 16A - 250V~</p> <ul style="list-style-type: none"> <li>■ Inclined 45°.</li> <li>■ Supplied with Blocking Pin for MEC Q45 sockets (Ref. 45991).</li> </ul> 	45136 S	
 <p><b>45° Schuko Socket with Blockage and Signal Light - 2 Modules</b> 16A - 250V~</p> <ul style="list-style-type: none"> <li>■ Inclined 45°.</li> <li>■ Supplied with Blocking Pin for MEC Q45 sockets (Ref. 45991).</li> </ul> 	45137 S	







POWER SOCKETS			Ref.	Color
<b>FRENCH SOCKETS</b>				
	Shutter Socket with Screwless Terminals (French Type) - 2 Modules 16A - 250V~		45476 S	BR BM PM AL LR VD VM
	Shutter Socket with Screwless Terminals and Hinged Lid (French Type) - 2 Modules 16A - 250V~		45477 S	
	Shutter Socket with Hinged Lid (French Type) - 2 Modules 16A - 250V~		45479 S	BR BM PM AL LR VD VM
	Shutter Socket with Hinged Lid (French Type) - 2 Modules 16A - 250V~		45475 S	
	45° Shutter Socket (French Type) - 2 Modules 16A - 250V~ ■ Inclined 45°.		45112 S	BR BM PM AL LR VD VM
	45° Socket (French Type) - 2 Modules 16A - 250V~ ■ Inclined 45°.		45111 S	
	45° Socket with Blockage (French Type) - 2 Modules 16A - 250V~ ■ Inclined 45°. ■ Supplied with Blocking Pin for MEC Q45 sockets (Ref. 45991).		45116 S	VM
	45° Socket with Blockage and Signal Light (French Type) - 2 Modules 16A - 250V~ ■ Inclined 45°. ■ Supplied with Blocking Pin for MEC Q45 sockets (Ref. 45991).		45117 S	
<b>EURO-AMERICAN SOCKETS</b>				
	Euro-American Shutter Socket (Euro-USA type) - 2 Modules 15A - 127V~/ 16A - 250V~		45142 S	BR BM PM AL VM
	Euro-American Socket (Euro-USA type) - 2 Modules 15A - 127V~/ 16A - 250V~		45140 S	
<b>AMERICAN SOCKETS</b>				
	American NEMA Shutter Socket (USA NEMA type) - 2 Modules 15A - 127V~ ■ SASO 2204. ■ NEMA 5-15.		45144 S	BR BM PM AL VM
	Double American Shutter Socket (USA) 2P+T 127V 15A - 3 Modules 15A - 127V~		45147 S	BR BM PM AL VM
	Double American Socket (USA) 2P+T 127V 15A - 3 Modules 15A - 127V~		45146 S	BR BM PM AL
	Double American 20A GFCI Shutter Socket 2P+T 127V - 3 Modules 20A - 127V~ ■ Support frame included. ■ Technical Data Sheet - page 62.	 	41148 X	BL NG
	Double American 15A GFCI Shutter Socket 2P+T 127V - 3 Modules 15A - 127V~ ■ Support frame included. ■ Technical Data Sheet - page 62.	 	41149 X	







POWER SOCKETS			Ref.	Color
<b>ITALIAN SOCKETS</b>				
	<b>Italian 10A Shutter Socket - 1 Module</b> 10A - 250V~		45423 S	BR BM PM AL VM
	<b>Italian 16A Shutter Socket - 1 Module</b> 16A - 250V~		45425 S	
	<b>Italian 10/16A Shutter Socket - 1 Module</b> 16A - 250V~		45421 S	
<b>BRAZILIAN SOCKETS</b>				
	<b>Brazilian 10A Shutter Socket - 1 Module</b> 10A - 250V~	 	45413 S	BR BM PM AL VM
	<b>Brazilian 10A Socket - 1 Module</b> 10A - 250V~		45412 S	
	<b>Brazilian 20A Shutter Socket - Module</b> 20A - 250V~	 	45415 S	
	<b>Brazilian 20A Socket - Module</b> 20A - 250V~		45414 S	
<b>MEC Q45 ACCESSORIES</b>				
	<b>Protective Cover for Support Frame and Mechanism - 2 Modules</b>		42980	—
	<b>Protective Cover for Support Frame and Mechanism - 3 Modules</b>		41984	
	<b>Spirit Mounting Level</b>		81989	
	<b>Blank Plate - 2 Modules</b>		45677 S	BR BM PM AL
	<b>Blank Plate - 1 Module</b>		45973 S	
	<b>Blocking Pin for MEC Q45 Sockets</b> ■ For use with sockets: Ref. 45136 S, 45137 S, 45116 S and 45117 S.		45991	—
	<b>Multifunctions IR Remote Control Transmitter</b> ■ To control Multifunctional Thermostat Ref. 45236 S. ■ To control Electric Shutters controllers Ref. 45311 S and 45312 S. ■ To control Surrounding Sound System - Jazz Light. ■ Requires CR 2032 battery (not included).		81900	—

# MEC Q45

SUPPORT FRAMES		Ref.	Color
<b>EUROPEAN MATRIX</b>			
	Support Frame with Claws - 2 Modules	42994	—
	Support Frame - 2 Modules	42993	
<b>ITALIAN MATRIX</b>			
	Support Frame up to 3 Modules	41994	—
	Support Frame up to 3+3 Modules	41995	
	Support Frame up to 4 Modules	41996	
	Support Frame up to 6 Modules	41997	
	<b>90° Positioner for Support Frames</b> ■ Vertical crossbar for side mounting of MEC Q45 mechanisms.	41992	

SURFACE BOXES		Ref.	Color
<b>EUROPEAN MATRIX</b>			
	<b>Surface Box - 2 Modules</b> ■ Support Frame to use: 2 Modules (Ref. 42993).	42985 A	BR BM PM AL
	<b>48 Series Box with Hinged Lid for MEC Q45</b> ■ Enables the installation of MEC Q45 mechanisms on the 48 Series with IP65 (except Motion Detectors and R-TV-SAT sockets).	48998 C	CZ BR
<b>ITALIAN MATRIX</b>			
	<b>Surface Box - 3 Modules</b> ■ Support Frame to use: 3 Modules (Ref. 41994).	41986 A	BR BM PM AL
	<b>Surface Box - 3+3 Modules</b> ■ Support Frame to use: 3+3Modules (Ref. 41995).	41987 A	
	<b>Surface Box - 4 Modules</b> ■ Support Frame to use: 4 Modules (Ref. 41996).	41988 A	
	<b>Surface Box - 6 Modules</b> ■ Support Frame to use: 6 Modules (Ref. 41997).	41989 A	

FRAMES AND SUPPORT FRAMES - EUROPEAN MATRIX





		HORIZONTAL MOUNTING		OR		VERTICAL MOUNTING	
		Single 42910 T	Double 42920 T	Triple 42930 T	Four-Gang 42940 T	Support Frame 42993	Support Frame with Claws 42994
		Color	Color	Color	Color		
BASE		BR	BR	BR	BR	✓	✓
AQUARELLA		BM PM AL	BM PM AL	BM PM AL	BM PM AL	✓	✓
LYRA		CE AZ AM VR LR RJ	CE AZ AM VR LR RJ	CE AZ AM VR LR RJ	CE AZ AM VR LR RJ	✓	✓
LIGNA		RO FA MG WG	RO FA MG WG	RO FA MG WG	RO FA MG WG	✓	✓
METALLUM		LU RB CO OR CR	LU RB CO OR CR	LU RB CO OR CR	LU RB CO OR CR	✓	✓
CROMA		BH AH PH	BH AH PH	BH AH PH	BH AH PH	✓	✓

- T - Rocker, Cover Plate or Frame
  - BASE: BR - White.
  - AQUARELLA: AL - Aluminium; PM - Matte Black; BM - Matte White.
  - LYRA: CE - Beige; AZ - Blue; AM - Yellow; VR - Green; LR - Orange; RJ - Red.
  - LIGNA: RO - Oak; FA - Beech; MG - Mahogany; WG - Wenge.
  - METALLUM: LU - Aluminium; RB - Ruddy; CO - Copper; OR - Gold; CR - Chrome.
  - CROMA: BH - Matte White / Chrome; AH - Aluminium / Chrome; PH - Matte Black / Chrome.
- Frames dimensions - page 63.

		3 MODULES				
		1 MODULE 41913 T	2 MODULES 41914 T	1+1 MODULES 41915 T	3 MODULES 41916 T	Support Frame 41994
						
		Color	Color	Color	Color	
BASE		BR	BR	BR	BR	✓
AQUARELLA		BM PM AL	BM PM AL	BM PM AL	BM PM AL	✓
LYRA		-	-	-	CE AZ AM VR LR RJ	✓
LIGNA		-	-	-	RO FA MG WG	✓
METALLUM		-	-	-	LU RB CO OR CR	✓
CROMA		-	-	-	BH AH PH	✓
CRYSTAL		-	-	-	CB CA CK EB EA EP	✓

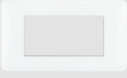
- T - Rocker, Cover Plate or Frame.
- BASE: BR - White.
- AQUARELLA: AL - Aluminium; PM - Matte Black; BM - Matte White.
- LYRA: CE - Beige; AZ - Blue; AM - Yellow; VR - Green; LR - Orange; RJ - Red.
- LIGNA: RO - Oak; FA - Beech; MG - Mahogany; WG - Wenge.
- METALLUM: LU - Aluminium; RB - Ruddy; CO - Copper; OR - Gold; CR - Chrome.
- CROMA: BH - Matte White / Chrome; AH - Aluminium / Chrome; PH - Matte Black / Chrome
- CRYSTAL: CB - Crystal / Matte White; CA - Crystal / Aluminium; CK - Crystal / Matte Black; EB - Black Crystal / Matte White; EA - Black Crystal / Aluminium; EP - Black Crystal / Matte Black.

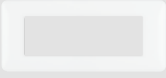
■ Frames dimensions - page 65.

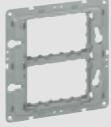
4 MODULES		6 MODULES			
4 MODULES 41917 T	Support Frame 41996	6 MODULES 41918 T	Support Frame 41997	3+3 MODULES 41926 T	Support Frame 41995
					
Color		Color		Color	
BR	✓	BR	✓	BR	✓
BM PM AL	✓	BM PM AL	✓	BM PM AL	✓
CE AZ AM VR LR RJ	✓	CE AZ AM VR LR RJ	✓	CE AZ AM VR LR RJ	✓
RO FA MG WG	✓	RO FA MG WG	✓	RO FA MG WG	✓
LU RB CO OR CR	✓	LU RB CO OR CR	✓	LU RB CO OR CR	✓
BH AH PH	✓	BH AH PH	✓	BH AH PH	✓
—	—	—	—	CB CA CK EB EA EP	✓

- **T** - Rocker, Cover Plate or Frame
- **BASE: BR** - White.
- **AQUARELLA: AL** - Aluminium; **PM** - Matte Black; **BM** - Matte White.
- **LYRA: CE** - Beige; **AZ** - Blue; **AM** - Yellow; **VR** - Green; **LR** - Orange; **RJ** - Red.
- **LIGNA: RO** - Oak; **FA** - Beech; **MG** - Mahogany; **WG** - Wenge.
- **METALLUM: LU** - Aluminium; **RB** - Ruddy; **CO** - Copper; **OR** - Gold; **CR** - Chrome.
- **CROMA: BH** - Matte White / Chrome; **AH** - Aluminium / Chrome; **PH** - Matte Black / Chrome
- **CRYSTAL: CB** - Crystal / Matte White; **CA** - Crystal / Aluminium; **CK** - Crystal / Matte Black; **EB** - Black Crystal / Matte White; **EA** - Black Crystal / Aluminium; **EP** - Black Crystal / Matte Black.

■ Frames dimensions - page 65.

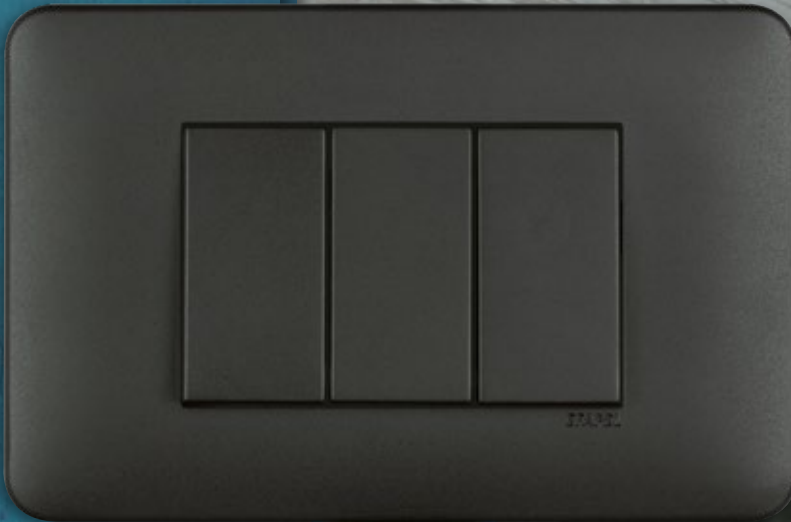

## TABLE OF CONTENTS

PAGE

■ CONNECTION DIAGRAMS	32
■ <b>MEC Q45</b> MECHANISMS	
■ CONTROL DEVICES	
- Single and Double Switches	35
- Digital Timer Switches	36
- Card-System Timer Switch	37
- Timer Switch	38
- 4-Gang Electronic Press-Button (Very Low Voltage)	39
■ DIMMERS	
- RLC Rotary Dimmer	40
- RLC Dimmer Press-Switch	41
■ MOTION DETECTORS	
- Motion Detector - Wall Installation	42
- Motion Detector	43
■ ORIENTATION AND LIGHT INDICATORS	
- Light Indicator / Triangular Overdoor Light Indicator	44
- White Orientation Light / White Orientation Light with Battery	45
- Electronic Buzzer	46
■ TEMPERATURE CONTROL	
- Rotary Thermostat	47
- Multifunctional Chronothermostat	48
- Multifunctional Thermostat	49
■ ELECTRIC SHUTTER CONTROLLERS	50
■ RELAYS FOR ELECTRIC SHUTTER CONTROLLERS	52
■ DATA, VOICE AND IMAGE SOCKETS	
- HDMI sockets	54
- Data Sockets - USB / VGA / RCA	55
■ CONNECTORS	
- RJ45 UTP Cat. 6A and 6 Connectors	56
■ RADIO / TV / SATELLITE SOCKETS	57
■ USB POWER SOCKETS	59
■ POWER SOCKETS	
- Single and Double Sockets	60
- Double GFCI Sockets	62
■ FRAMES	63
■ SUPPORT FRAMES	67

MEC Q45 - CONNECTION DIAGRAMS

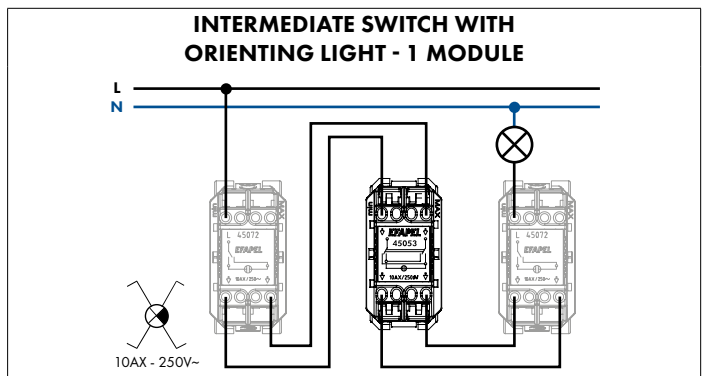
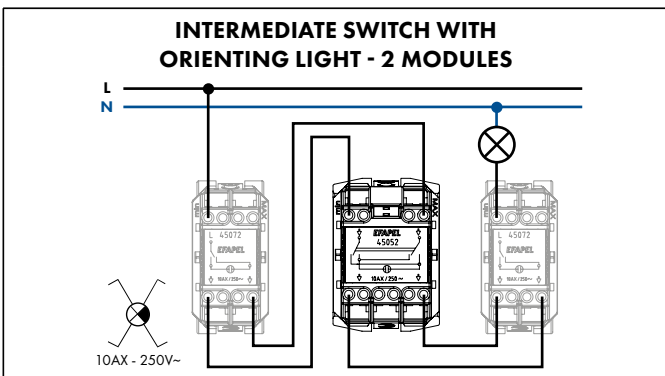
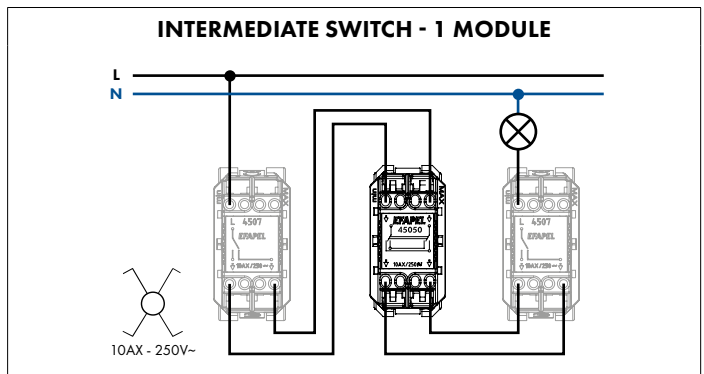
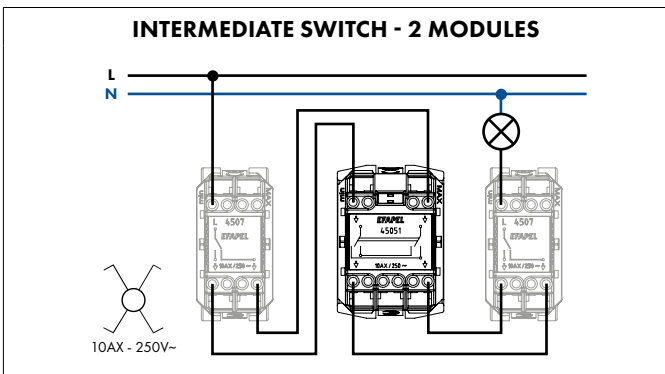
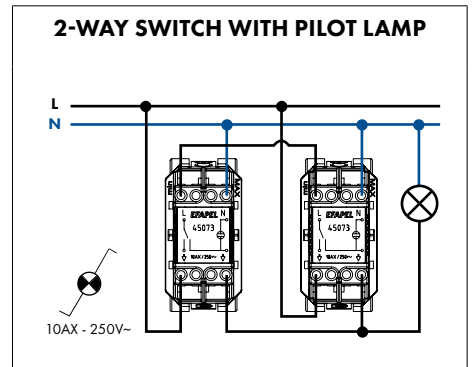
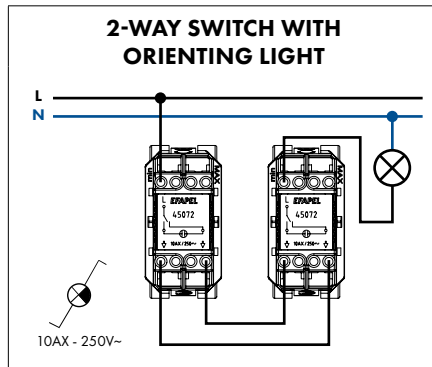
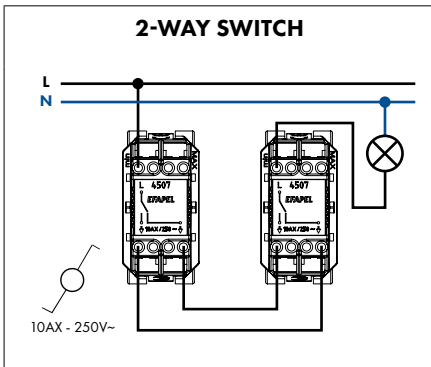
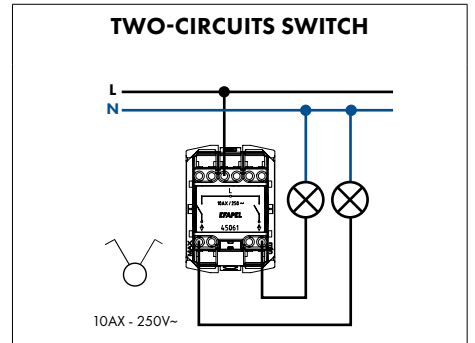
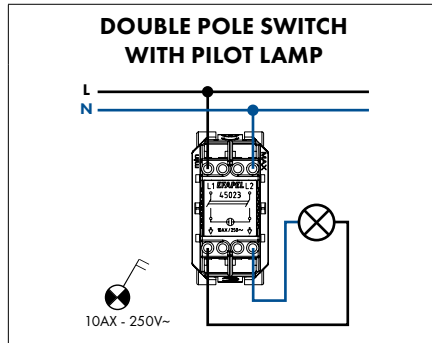
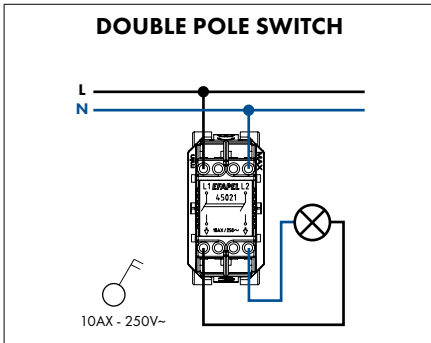
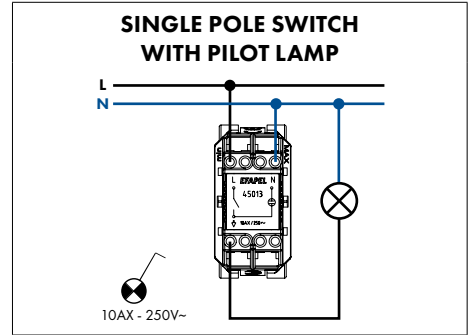
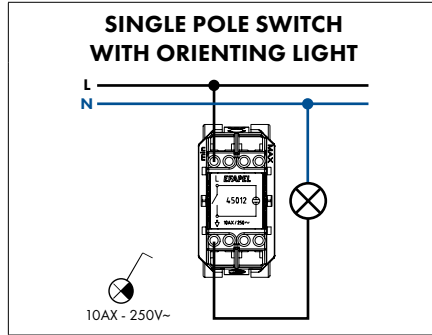
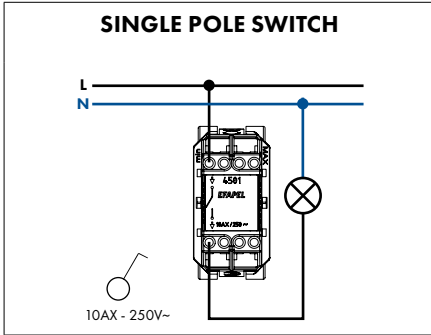



MEC Q45 - CONNECTION DIAGRAMS

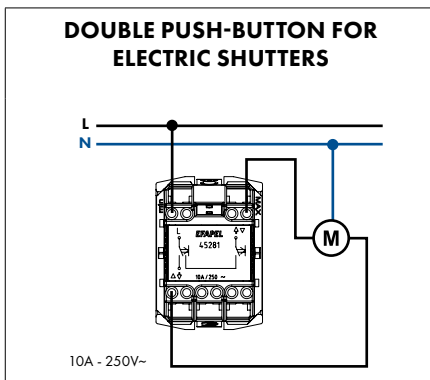
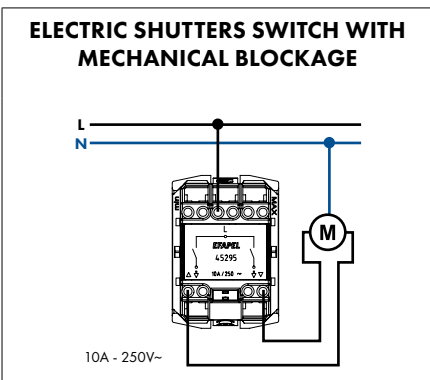
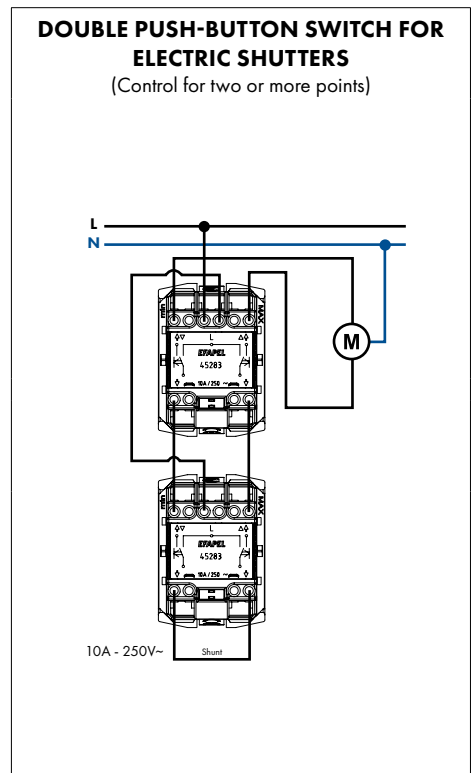
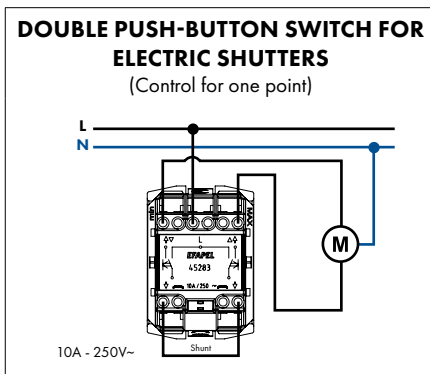
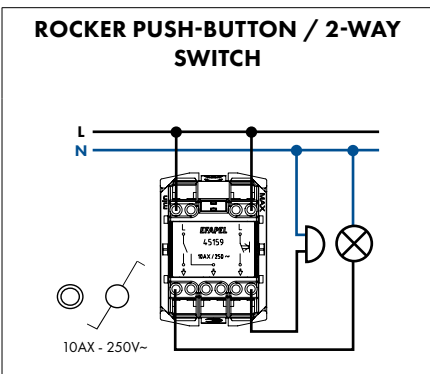
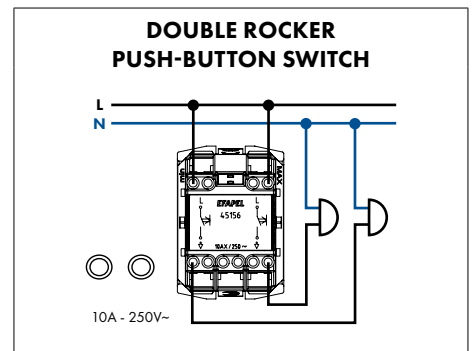
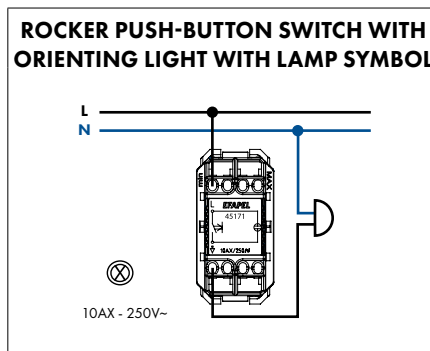
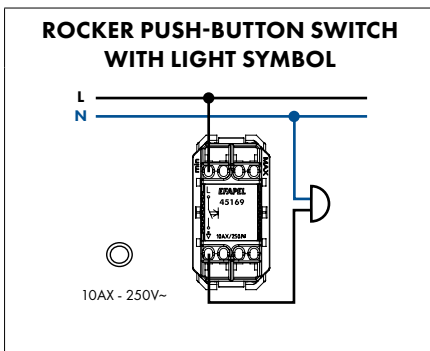
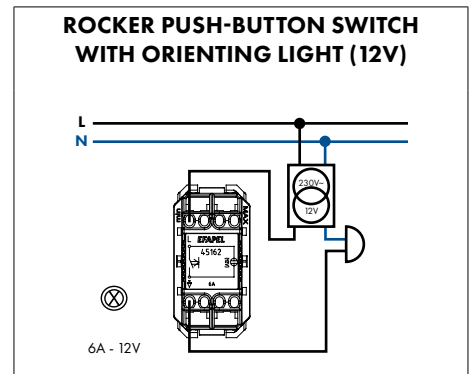
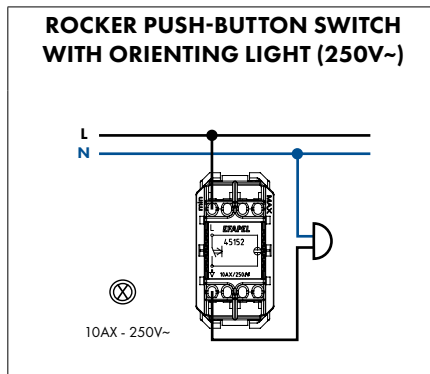
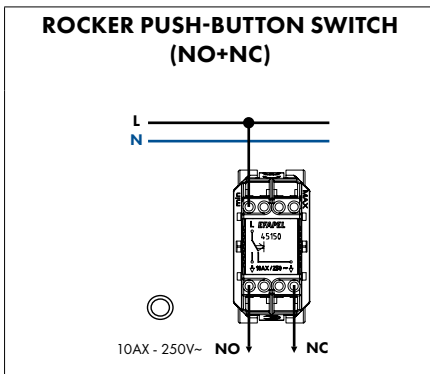
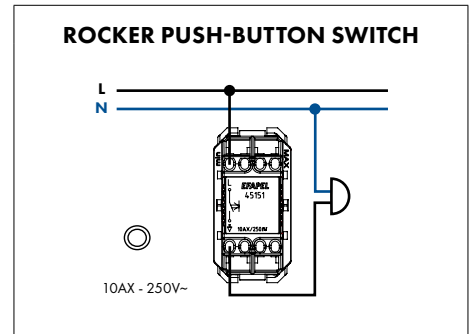
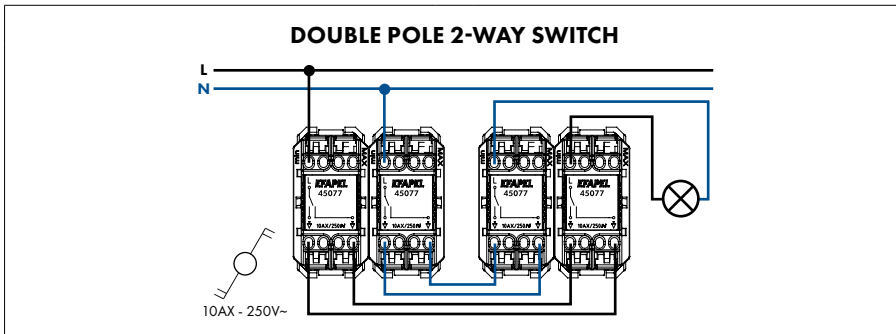

MEC Q45 - CONNECTION DIAGRAMS

**ROCKER SWITCH WITH INDEPENDENT PILOT LAMP (250 V~) - 1 MODULE**

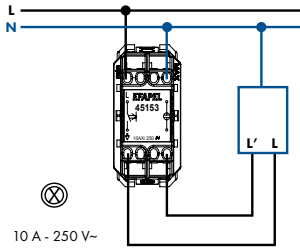

**ROCKER SWITCH WITH INDEPENDENT PILOT LAMP (12 V) - 1 MODULE**

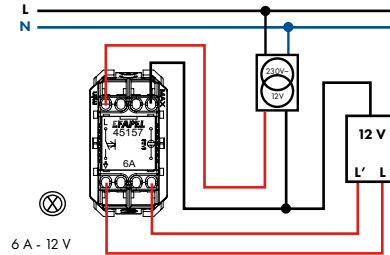

**KEY LOCK PUSH-BUTTON SWITCH - 2 MODULES**

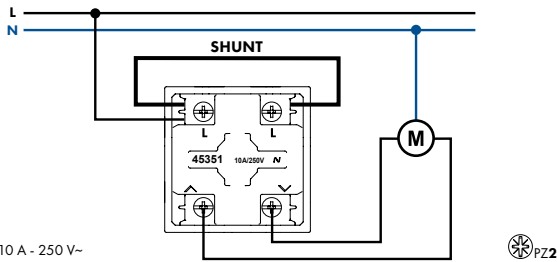

**KEY LOCK 2-WAY SWITCH - 2 MODULES**

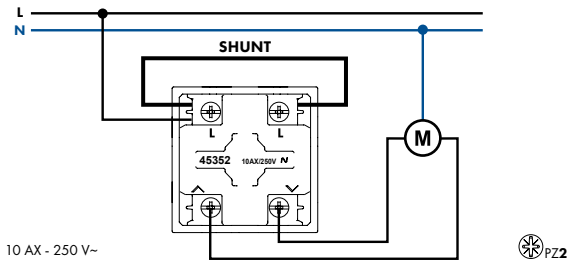

**PUSH-BUTTON PULL CORD SWITCH (NO+NC) - 2 MODULES**

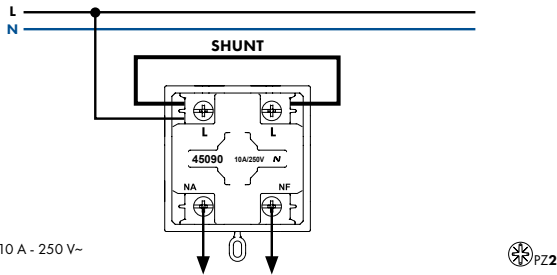

**2-WAY PULL CORD SWITCH - 2 MODULES**

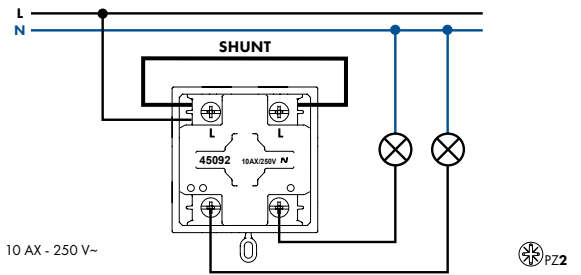

**ROTARY SWITCH - 2 MODULES**

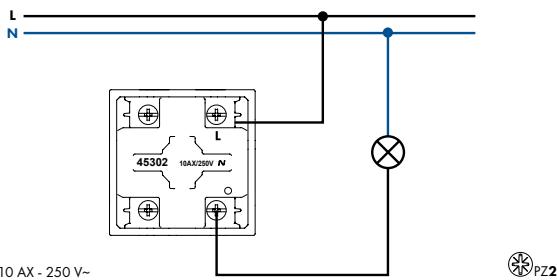

**ROTARY 2-WAY SWITCH - 2 MODULES**

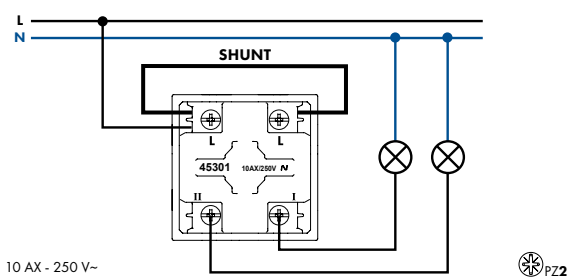

**ROTARY PUSH-BUTTON FOR ELECTRIC SHUTTERS - 2 MODULES**

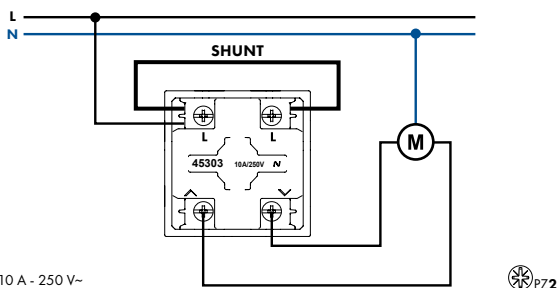

**ROTARY 2-WAY SWITCH FOR ELECTRIC SHUTTERS - 2 MODULES**

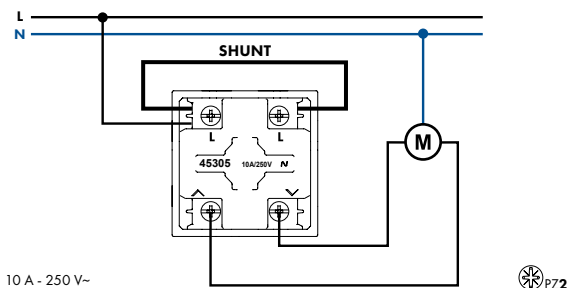

MEC Q45 - MECHANISMS

DESCRIPTION

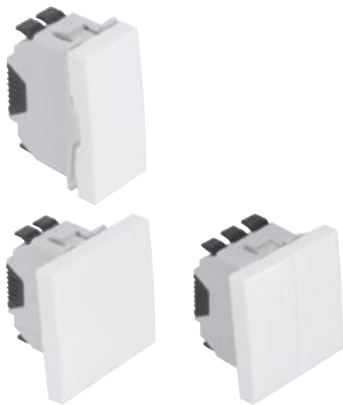

- **MEC Q45** Mechanisms.
- Installation:
  - Flush-mounted (Installed in apparatus box);
  - Surface (Installed in Surface Box);
  - Technical Trunking:
    - Mini Cable Trunking (Using the Surface Box with trunking adaptor);
    - Distribution Trunking (Using the **MEC Q45** Modular Adapter).
- Available in the following colours: **BR** - White (RAL 9003), **BM** - Matte White, **AL** - Aluminium, **PM** - Matte Black.

CHARACTERISTICS

■ **Technical Thermoplastic Mechanisms - non-conductive resistant material.**

■ **Control Devices**

- 10A - 250V~ - connections with **screw terminals** and **screwless terminals**. It allows the usage of rigid and flexible cable.
- In accordance with EN 60669-1 Standard, tested according 19.3:

Relationship between rated current of the switch and rated power of the SBL circuit	
Rated current of the switch, $I_n$ [A]	Rated power of the SBL circuit [W]
$I_n \leq 10$	100
$10 < I_n \leq 13$	150
$13 < I_n \leq 16$	200
$16 < I_n \leq 20$	250

SBL - Self Ballasted Lamp (CFL or LED)

DIMENSIONS (mm)

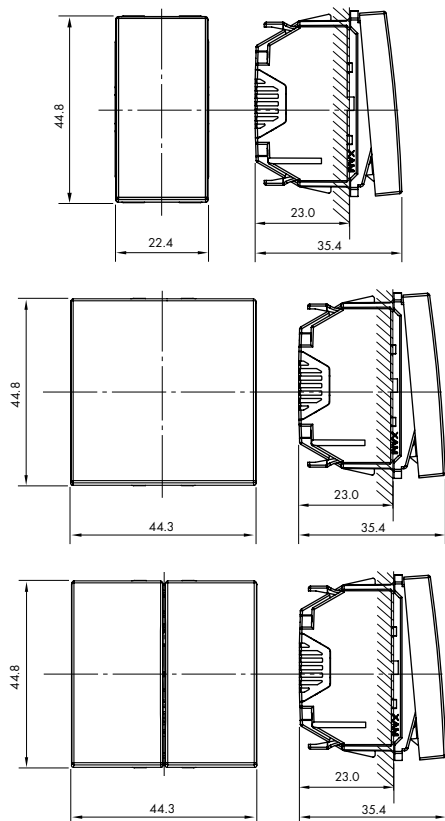

DIGITAL TIMER SWITCHES

DESCRIPTION



DIGITAL TIMER SWITCHES

- Ref. 45041 / 45042 S - MEC Q45 Mechanisms.
- Allows control of an installation or equipment according to a daily or weekly programme.
- Capable of memorising up to 24 operations.
- Automatic summer/winter time change and idle time programme (holidays).

OPERATION

- Manual ON/OFF status switching of each circuit.
- Programmable ON, OFF and PULSE switching (pulses from 1 to 59 seconds) for each circuit independently.

CHARACTERISTICS

- 1 Circuit: 16A (cosφ = 1) - 230V~ - 50/60Hz.
- 2 Circuits: 6A + 6A (cosφ = 1) - 230V~ - 50/60Hz.
- Consumption: < 1W.
- Memory spaces: 24.
- Functions: ON, OFF and PULSE (1 to 59 seconds).
- Programming accuracy: 1 second.
- Operating accuracy: ≤ 1 sec/day.
- Operating temperature: -10°C to +45°C
- Power reserve: 24 hours.
- Outputs: NO + NC.
- Potential-free output contact.

DIMENSIONS (mm)

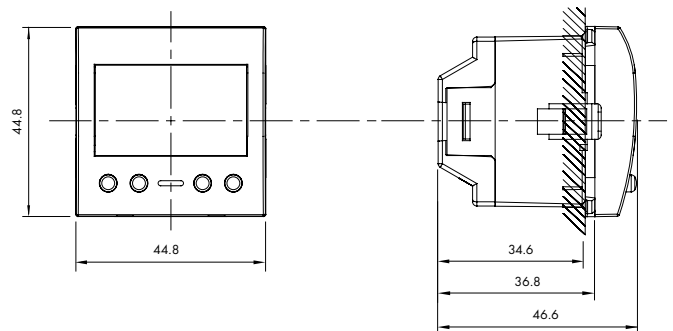

CONNECTION DIAGRAMS

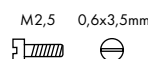
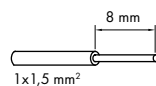
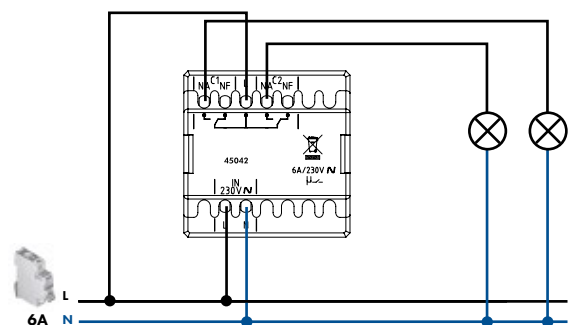
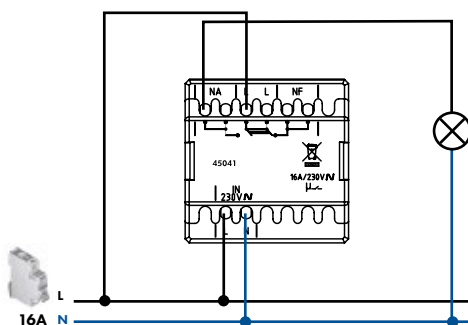

CARD-SYSTEM TIMER SWITCH

DESCRIPTION



CARD-SYSTEM TIMER SWITCH

■ Ref. 45033 S - MEC Q45 Mechanisms.

OPERATION

- Allows control of a circuit according to the presence of a card in the holder;
- When removing the card from the mechanism, the load remains On / Off for the pre-defined period of time.

CHARACTERISTICS - TECHNICAL

- Power: 100-240V~, 50/60 Hz;
- Maximum load: 16A (cosφ = 1);
- Adjustable disconnection delay: 0-60 seconds;
- Consumption: < 200mW;
- Operating temperature: -10°C to +45°C;
- Compatible with any load type:
  - Outputs: NO or NC;
  - Potential-free output contact.

CHARACTERISTICS - DEVICE

- Compatible with any type of bank card (ATM);
- Possibility of inserting a card in the Vertical or Horizontal position;
- Luminous function - whenever a card is inserted, the mechanism remains backlit.

DIMENSIONS (mm)

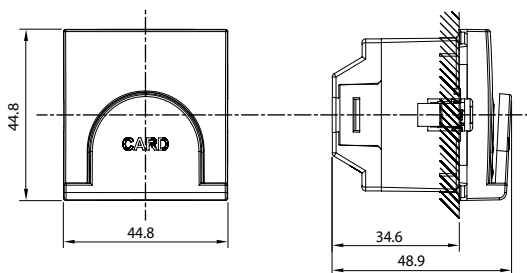

CONNECTION DIAGRAMS

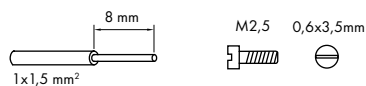
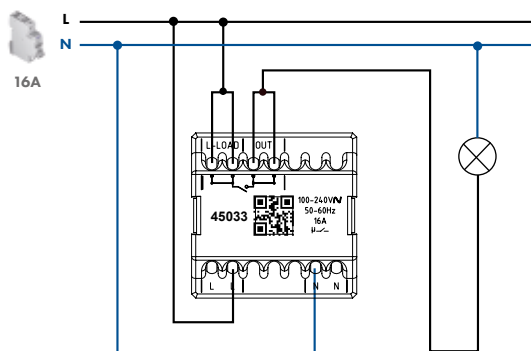

TIMER SWITCH

DESCRIPTION



TIMER SWITCH

■ Ref. 45040 S - MEC Q45 Mechanisms.

OPERATION

■ Allows to control a lighting circuit in a timed manner (by means of a defined timer) or ON / OFF.

CHARACTERISTICS - TECHNICAL

- Power: 100-240V~, 50/60 Hz;
- Maximum load: 16A (cosφ = 1);
- Operating time regulation: 5 seconds to 15minutes
- Consumption: < 200mW;
- Operating temperature: -10°C to +45°C;
- Compatible with any load type:
  - Outputs: NO or NC;
  - Potential-free output contact.

CHARACTERISTICS - DEVICE

- Allows to control in more than one point (switching circuit) using push-buttons (NO);
- Four backlight settings:
  - Illuminated - backlighting on with load disconnected and off with load connected;
  - Pilot Lamp - backlighting off with load disconnected and on with load connected;
  - Always ON - backlighting always on;
  - Off - backlighting off.

DIMENSIONS (mm)

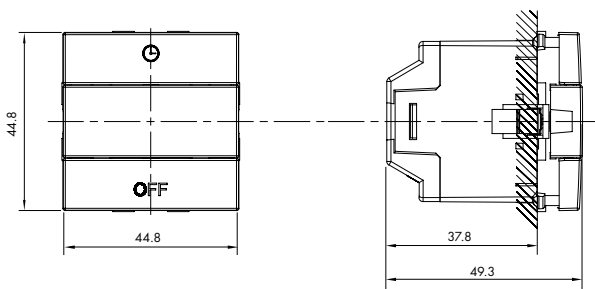

OPERATION DIAGRAM

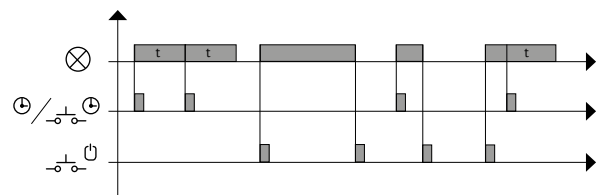

CONNECTION DIAGRAMS

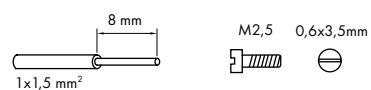
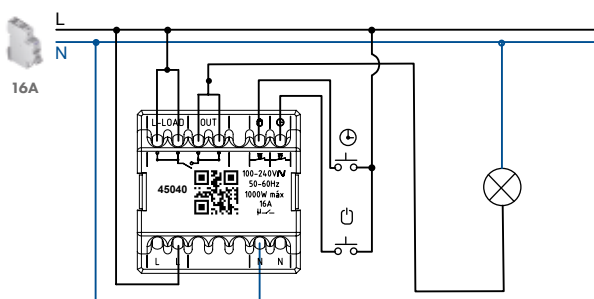

**4-GANG ELECTRONIC PRESS BUTTON (VERY LOW VOLTAGE)**

**DESCRIPTION**



**4-GANG ELECTRONIC PRESS BUTTON (VERY LOW VOLTAGE)**

- Ref. 45164 S - MEC Q45 Mechanisms.
- Compatible with input modules of different home automation systems.
- One common input and four independent "dry" contact outputs.
- Contact opening and closing via a microswitch (potential-free and **Very Low Voltage - VLV**).

**OPERATION**

- Press each key to close the circuit.

**CHARACTERISTICS**

- Maximum power dissipation: **60mW (DC 12V 50mA)**;
- Maximum voltage: **32V<sup>~</sup>**;
- Insulation resistance:  $\geq 100M\Omega$ ;
- Dielectric rigidity: AC 250V~ 50Hz/ 1 min.;
- Operating temperature: -25C° to +70°C.
- Maximum relative humidity: (40°C)  $\leq 95\%$ .
- Contact resistance:  $\leq 40m\Omega$ ;
- Outputs: 4NO.

**DIMENSIONS (mm)**

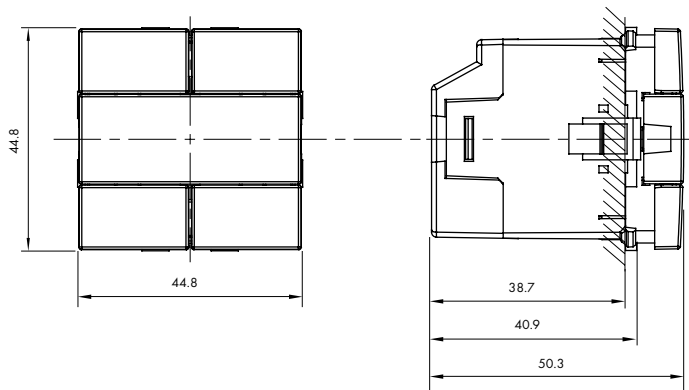

**ELECTRICAL DIAGRAM**

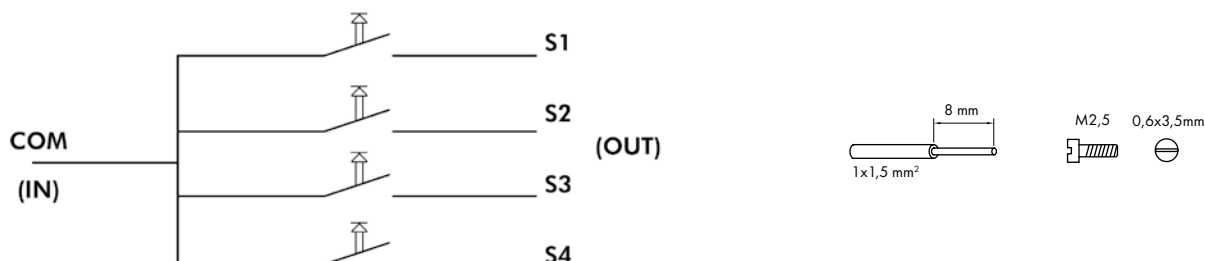

RLC ROTARY DIMMER

DESCRIPTION



RLC ROTARY DIMMER

■ Ref. 45216 S - MEC Q45 Mechanisms.

OPERATION

- Allows to command ON / OFF and the regulation of the dimming of a lamp or set of lamps:
  - Regulation of the dimming by rotation or through continuous pressure on the button;
  - Short button press, switches ON/OFF position..

CHARACTERISTICS - TECHNICAL

- Power: **100-240V~, 50/60 Hz;**
- Consumption: < 200mW;
- Operating temperature: -10 °C to 45 °C;
- **Note:** Maximum recommended number of lamps per circuit = 10;  
In the event of excessive load, short-circuit, inadequate current (dimmable lamps or a mixture of various types of dimmable lamps) - the frontal white LED will start flashing.

CHARACTERISTICS - DEVICE

- No need for a neutral line (directly replaces a Single Pole Switch);
- Compatible with RLC circuits (R, RL and RC);
- Memorizes last lighting level;
- Allows to control at more than one point (switching circuit) with the use of Rocker switches (NO).

DIMENSIONS (mm)

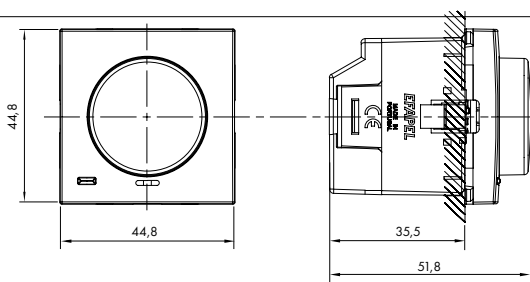

OPERATION DIAGRAM (EXTERNAL INPUT)

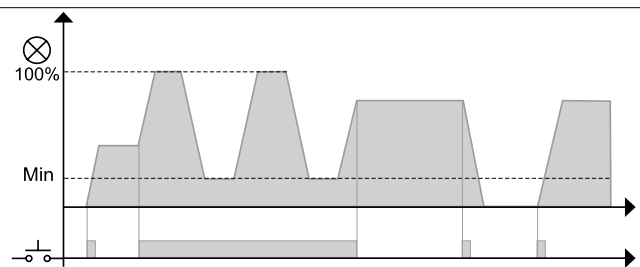

CONNECTION DIAGRAMS

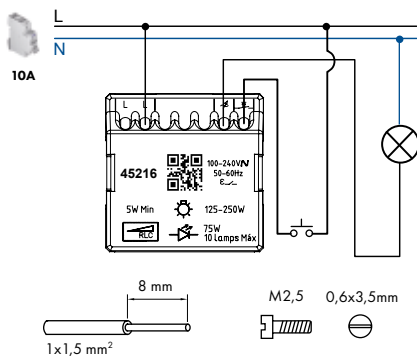

MAXIMUM RECOMMENDED LOADS								
	Voltage	[P]	Incandescent	Halogen	Ferromagnetic Transformer	Electronic Transformer	Compact Fluorescent	LED
REF. 45216 S	230V~	5W	250W	250W	250VA	250VA	75W or 10 lamps (Máx.)	75W or 10 lamps (Máx.)
100-240V~50/60HZ	110V~	5W	125W	125W	125VA	125VA	75W or 10 lamps (Máx.)	75W or 10 lamps (Máx.)



RLC DIMMER PRESS SWITCH

DESCRIPTION



RLC DIMMER PRESS SWITCH

■ Ref. 45218 S - MEC Q45 Mechanisms.

OPERATION

■ Allows to command ON / OFF and the regulation of the dimming of a lamp or set of lamps.

CHARACTERISTICS - TECHNICAL

- Power: 100-240V~, 50/60 Hz;
- Consumption: < 200mW;
- Operating temperature: -10 °C to 45 °C;
- **Note:** Maximum recommended number of lamps per circuit = 10;  
In the event of excessive load, short-circuit, inadequate current (dimnable lamps or a mixture of various types of dimmable lamps) - the frontal white LEDs will start flashing.

CHARACTERISTICS - DEVICE

- No need for a neutral line (directly replaces a Single Pole Switch);
- Compatible with RLC circuits (R, RL and RC);
- Allows to control at more than one point (switching circuit) with the use of Rocker switches (NO).
- Four backlight settings:
  - Illuminated - backlighting on with load disconnected and off with load connected;
  - Pilot Lamp - backlighting off with load disconnected and on with load connected;
  - Always ON - backlighting always on;
  - Off - backlighting off.

DIMENSIONS (mm)

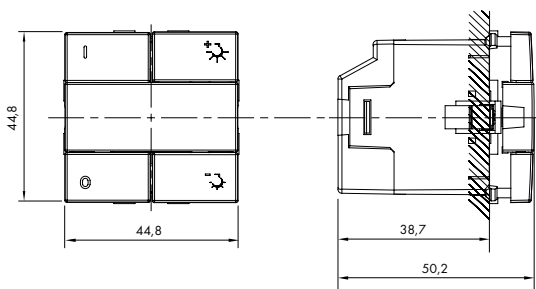

OPERATION DIAGRAM (EXTERNAL INPUT)

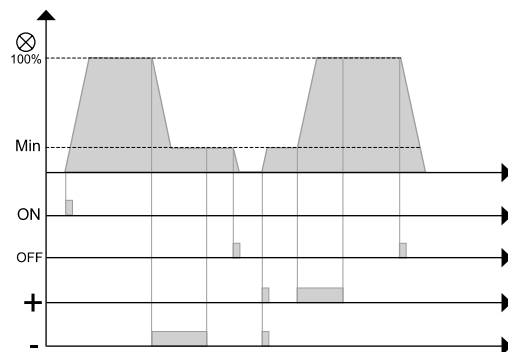

CONNECTION DIAGRAMS

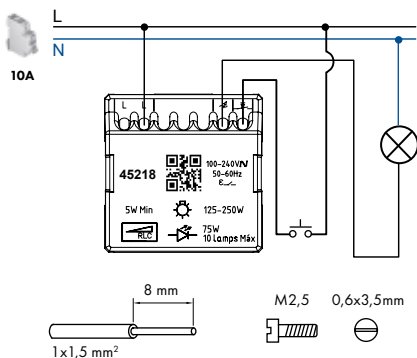

MAXIMUM RECOMMENDED LOADS								
	Voltage	[P]	Incandescent	Halogen	Ferromagnetic Transformer	Electronic Transformer	Compact Fluorescent	LED
REF. 45218 S	230V~	5W	250W	250W	250VA	250VA	75W or 10 lamps (Máx.)	75W or 10 lamps (Máx.)
	100-240V~ 50/60HZ	5W	125W	125W	125VA	125VA	75W or 10 lamps (Máx.)	75W or 10 lamps (Máx.)

MOTION DETECTOR - WALL INSTALLATION

DESCRIPTION



MOTION DETECTOR - WALL INSTALLATION

■ Ref. 45403/ 45404 S - MEC Q45 Mechanisms.

CONFIGURATION AND OPERATION

- Automatically controls a circuit depending on motion detection and ambient brightness;
- Wall Installation;
- Adjustable light sensitivity;
- Motion detection indicator and front push-button.

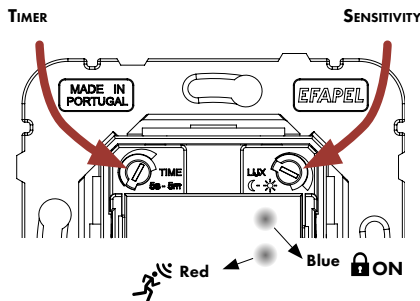

RANGE AND DETECTION ANGLE

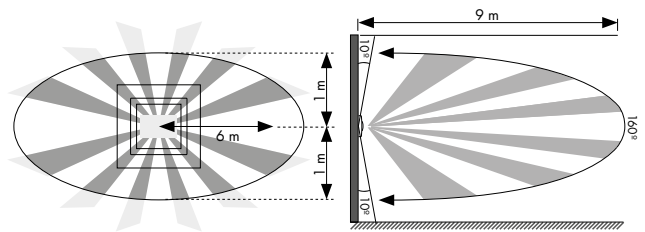

CHARACTERISTICS - TECHNICAL

- Power: 100-240V~, 50/60 Hz;
- Maximum load:
  - Ref. 45403 S – 1000W;
  - Ref. 45404 S – 400W;
- Timing adjustment: 5 seconds to 5 minutes;
- Consumption: < 250mW;
- Operating temperature: -10°C to 45°C.

CHARACTERISTICS - DEVICE

- Indication of motion detection in the detector by LED (Red);
- Compatible with any load type (Potential-free output contact - NO);
- Allows control via external inputs with Push-buttons (NO):
  - ⊕ – starts new timing;
  - ⊖ – switch to ON Manual mode.

DIMENSIONS (mm)

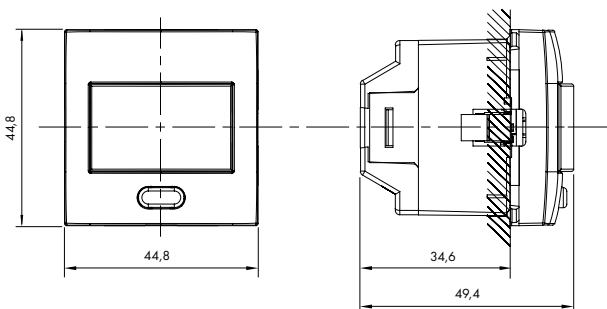

OPERATION DIAGRAM

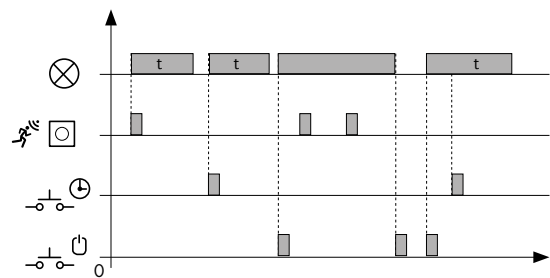

CONNECTION DIAGRAMS

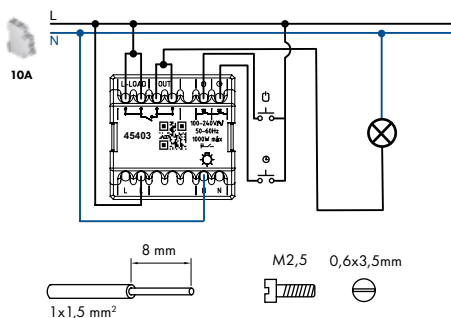

MAXIMUM RECOMMENDED LOADS							
REF.	Voltage - V	Incandescent	Halogen	Ferromagnetic Transformer	Electronic Transformer	Compact	LED
45403 S	100-240V~ 50/60Hz	1000W	1000W	750VA	750VA	500VA	500VA
45404 S	100-240V~ 50/60Hz	400W	400W	300VA	300VA	200VA	200VA

MOTION DETECTOR

DESCRIPTION



MOTION DETECTOR

■ Ref. 45401 / 45402 S - MEC Q45 Mechanisms.

CONFIGURATION AND OPERATION

- Automatically controls a circuit depending on motion detection and ambient brightness;
- Adjustable light sensitivity;
- Motion detection indicator.

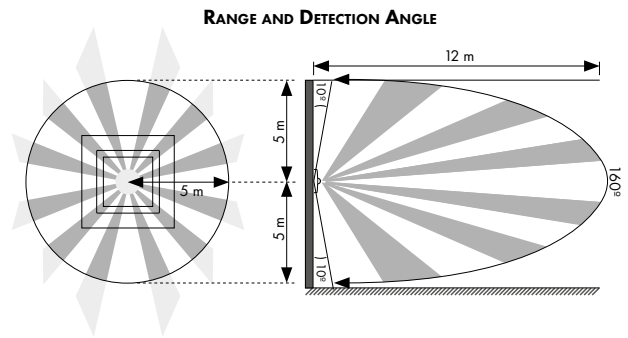
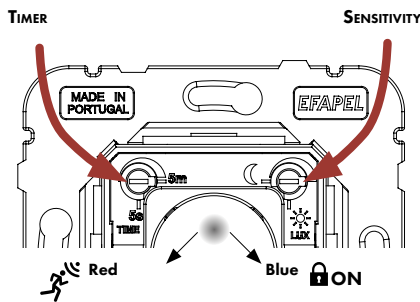

CHARACTERISTICS - TECHNICAL

- Power: 100-240V~, 50/60 Hz;
- Maximum load:
  - Ref. 45401 S - 1000W;
  - Ref. 45402 S - 400W;
- Timing adjustment: 5 seconds to 5 minutes;
- Consumption: < 250mW;
- Operating temperature: -10°C to 45°C.

CHARACTERISTICS - DEVICE

- Indication of motion detection in the detector by LED (Red);
- Compatible with any load type (Potential-free output contact - NO);
- Allows control via external inputs with Push-buttons (NO):
  - ⊕ - starts new timing;
  - ⊖ - switch to ON Manual mode.

DIMENSIONS (mm)

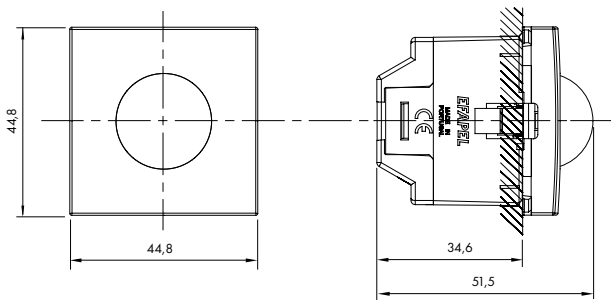

OPERATION DIAGRAM

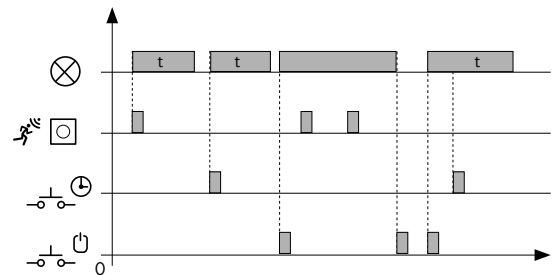

CONNECTION DIAGRAMS

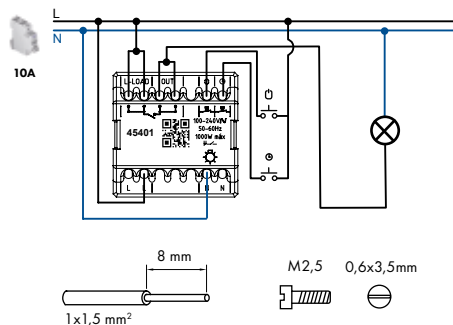

MAXIMUM RECOMMENDED LOADS							
REF.	Voltage - V	Incandescent	Halogen	Ferromagnetic Transformer	Electronic Transformer	Compact	LED
45401 S	100-240V~ 50/60Hz	1000W	1000W	750VA	750VA	500VA	500VA
45402 S	100-240V~ 50/60Hz	400W	400W	300VA	300VA	200VA	200VA

LIGHT INDICATOR | TRIANGULAR OVERDOOR LIGHT INDICATOR

DESCRIPTION



LIGHT INDICATOR

■ Ref. 45361 S - MEC Q45 Mechanisms.

TRIANGULAR OVERDOOR LIGHT INDICATOR

■ Ref. 45362 S - MEC Q45 Mechanisms.

■ For colored versions select the frontal covering:



- - IC - Colorless;
- - LR - Orange;
- - VD - Green;
- - VM - Red.

OPERATION

■ Light / Visual Signaling Mechanism with two levels of lightning.

CHARACTERISTICS

- Power: 230V~, 50/60 Hz;
- Two levels of intensity:
  - L1 – 0,2W;
  - L2 – 0,4W;
- Operating temperature: -10° C to 45° C.
- Color temperature: 4000K.

DIMENSIONS (mm)

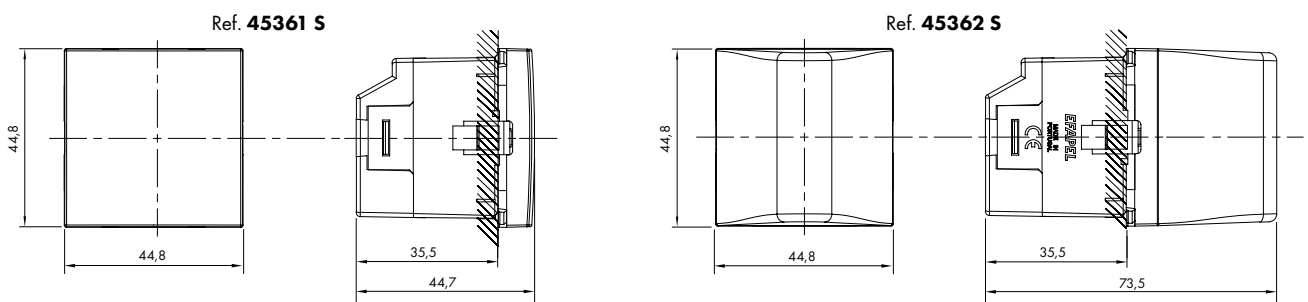

CONNECTION DIAGRAMS

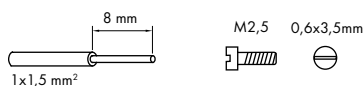

WHITE ORIENTATION LIGHT | WHITE ORIENTATION LIGHT WITH BATTERY

DESCRIPTION



WHITE ORIENTATION LIGHT

■ Ref. 45388 S - MEC Q45 Mechanisms.

WHITE ORIENTATION LIGHT WITH BATTERY

■ Ref. 45389 S - MEC Q45 Mechanisms.

OPERATION

Ref. 45388 S

■ Light / Visual Signaling Mechanism with two levels of lightning;

Ref. 45389 S

■ Light / Visual Signaling Mechanism, allows to operate as Orientation Light and Orientation Light with Battery.

■ In the event of a power failure, it maintains visual signaling for 1 hour.

CHARACTERISTICS - Ref. 45388 S

- Power: 230V~, 50/60 Hz;
- LED signaling;
- Two levels of intensity:
  - L1 – 0,2W;
  - L2 – 0,4W;
- Operating temperature: -10 °C to 45 °C.
- Color temperature: 4000K.

CHARACTERISTICS - Ref. 45389 S

- Power: 230V~, 50/60 Hz;
- LED signaling;
- Three forms to operate:
  - "L1" – Signaling OFF (turns on only after power failure);
  - "L2" – Signaling ON (always on, until the battery is drained out after a power failure).
  - "L1"+"L2" - Orientation Light and Orientation Light with Battery.
- Charging time: 36 hours;
- Autonomy: 1 hour;
- Operating temperature: -10 °C to 45 °C.

DIMENSIONS (mm)

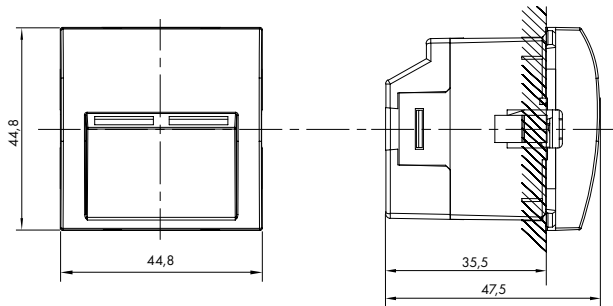

CONNECTION DIAGRAMS

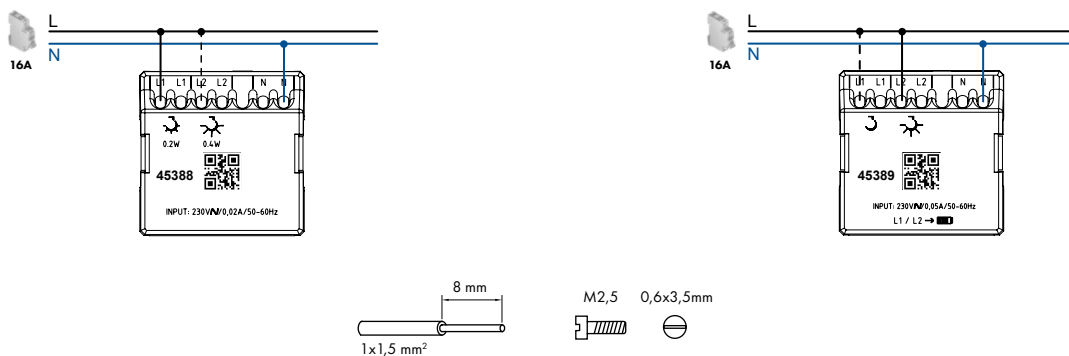

ELECTRONIC BUZZER

100-240V~  
50/60 Hz

DESCRIPTION



ELECTRONIC BUZZER

■ Ref. 45369 S MEC Q45 Mechanisms.

OPERATION

■ Being powered emits sound.

CHARACTERISTICS

- Operating voltage: 100-240V~.
- Frequency: 50/60Hz.
- Type: D (type D sound signal).
- Acoustic level: 80 dB at 1 m.
- Operating cycle: intermittent 5/15s.
- Operating temperature: -10°C to 45°C.

DIMENSIONS (mm)

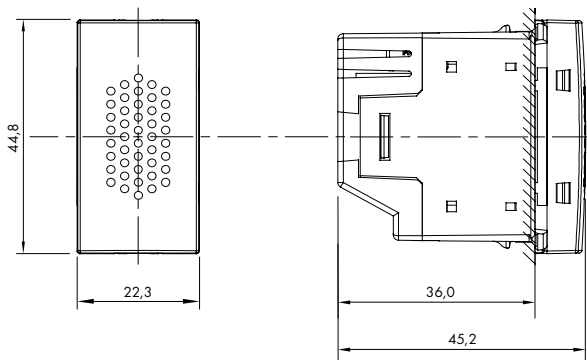

CONNECTION DIAGRAMS

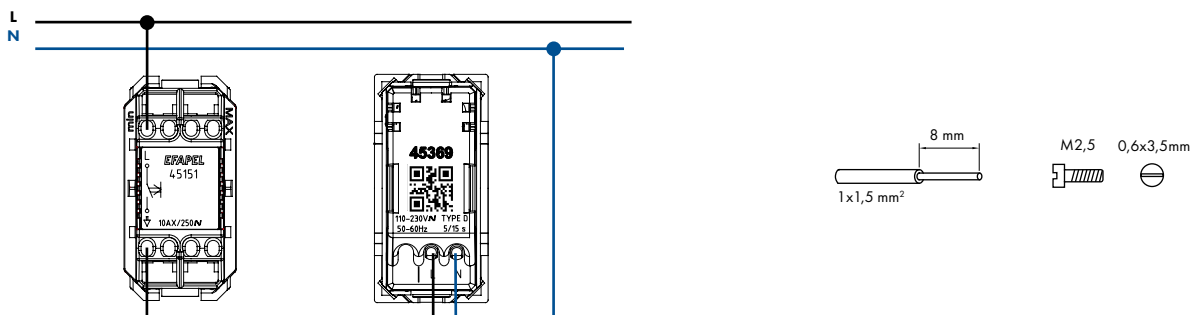

TEMPERATURE CONTROL - ROTARY THERMOSTAT

DESCRIPTION



ROTARY THERMOSTAT

- Ref. 45234 S - MEC Q45 Mechanisms.
- Allows to control of Heating and/or Cooling system depending on the set temperature.
- Compatible with Floor Probe (Ref. 81950) - automatic detection.
- Compatible with electrical and hydraulic systems.

OPERATION

Constant selection and control of the desired ambient temperature through direct push-button setting.

- Red LED – Heating Control;
- Blue LED - Cooling.

CHARACTERISTICS - TECHNICAL

- Power: 100-240V~, 50/60 Hz;
- Maximum load: 16A (cosφ = 1);
- Consumption: < 200mW;
- Operating temperature: -10°C to 45°C;
- Temperature settings: +5°C to 30°C;
- Temperature reading range: -9°C to 35°C;
- Output: NO.

CHARACTERISTICS - DEVICE

- System control: Heating and/or Cooling;
- Compatible with Floor Probe (Ref. 81950) - automatic detection;
- Antifreeze Protection (Heating) and Thermal Protection (Cooling);
- Compatible with electrical and hydraulic systems.

DIMENSIONS (mm)

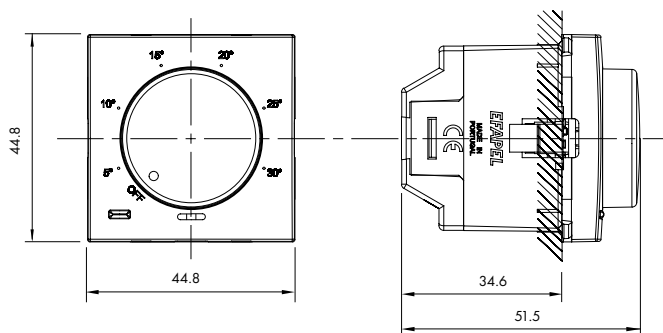

CONNECTION DIAGRAMS (HEATING / COOLING)

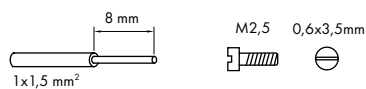
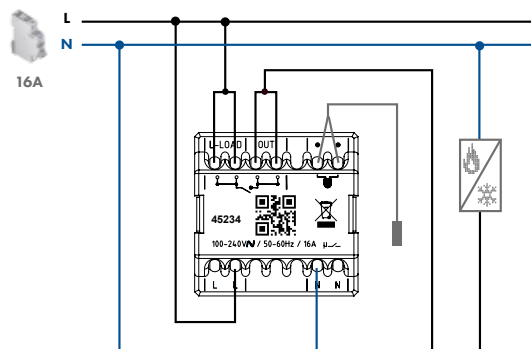

TEMPERATURE CONTROL - MULTIFUNCTIONAL CHRONOTHERMOSTAT

DESCRIPTION



MULTIFUNCTIONAL CHRONOTHERMOSTAT

- Ref. 45235 S - MEC Q45 Mechanisms;
- Allows manual and automatic control of the Heating and Cooling system according to daily/weekly programming and pre-programmed temperatures;
- Compatible with Floor Probe (Ref. 81950) - automatic detection;
- Automatic change of summer/winter time;
- Ability to programme inactive periods (holidays);
- Keys lock function;
- Compatible with electrical and hydraulic systems.

OPERATION

- Programming and control of the desired ambient temperatures for the different periods of the day (up to 7 different temperatures or periods per day) and for the different days of the week.
- Allows the adjustment of different parameters in order to obtain the most appropriate control for the needs of the installation (Climatization Type; Installation Type; Type of Control; Temperature Limits; Differential).

CHARACTERISTICS - TECHNICAL

- Power: 100-240V~, 50/60 Hz;
- Maximum load: 16A (cosφ = 1);
- Consumption with backlighting "ON" < 350mW;
- Consumption with backlighting "OFF" < 100mW;
- Operating temperature: -10°C to 45°C;
- Temperature control precision: 0.5°C;
- Temperature reading range: -9°C to 35°C;
- Power reserve up to 24 h;
- Output: NO.

CHARACTERISTICS - DEVICE

- System controls: Heating and/or Cooling;
- Compatible with Floor Probe (Ref. 81950) - automatic detection;
- Temperature reading: Ambient or Floor Probe or both;
- Antifreeze Protection;
- Compatible with electrical and hydraulic systems;
- Valve protection (hydraulic systems);
- Able to plan up to 7 daily periods;
- Keys lock function.

DIMENSIONS (mm)

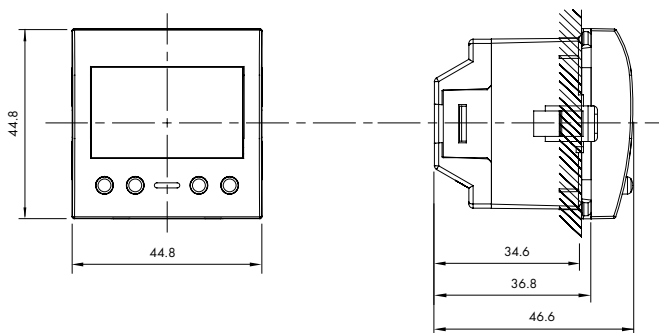

CONNECTION DIAGRAMS (HEATING / COOLING)

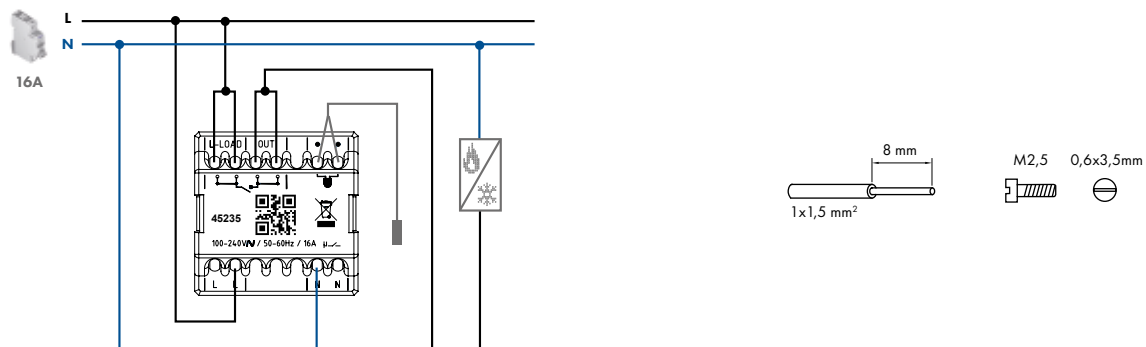



TEMPERATURE CONTROL - MULTIFUNCTIONAL THERMOSTAT

DESCRIPTION



MULTIFUNCTIONAL THERMOSTAT

- Ref. 45236 S - MEC Q45 Mechanisms;
- Allows to control of a Heating and/or Cooling system depending on the set temperature.
- Remote control possible with a Multifunctions IR Remote Control Transmitter (Ref. 81900);
- Floor Probe connection possible (Ref. 81950), with automatic detection;
- TIMER function (from 15 minutes to 6 hours);
- Keys lock function;
- Compatible with electrical and hydraulic systems.

OPERATION

- Selection and control of desired ambient temperature in a constant way.
- Allows the adjustment of different parameters in order to obtain the most appropriate control for the needs of the installation (Climatization Type; Installation Type; Type of Control; Temperature Limits; Differential).

CHARACTERISTICS - TECHNICAL

- Power: 100-240V~, 50/60 Hz;
- Maximum load: 16A (cosφ = 1);
- Consumption with backlighting "ON" < 350mW;
- Consumption with backlighting "OFF" < 100mW;
- Operating temperature: -10°C to 45°C;
- Temperature control precision: 0.5°C;
- Temperature reading range: -9°C to 35°C;
- Output: NO.

CHARACTERISTICS - DEVICE

- System controls: Heating and/or Cooling;
- Compatible with Floor Probe (Ref. 81950) - automatic detection;
- Temperature reading: Ambient or Floor Probe or both;
- Remote control possible with a Multifunctions IR Remote Control Transmitter (Ref. 81900);
- Antifreeze Protection;
- Compatible with electrical and hydraulic systems;
- Valve protection (hydraulic systems);
- TIMER function (from 15 minutes to 6 hours);
- Keys lock function.

DIMENSIONS (mm)

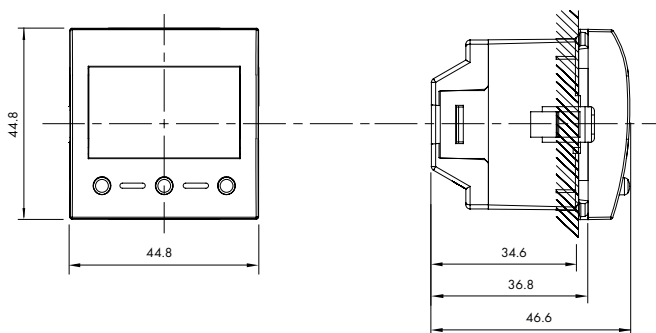

CONNECTION DIAGRAMS (HEATING / COOLING)

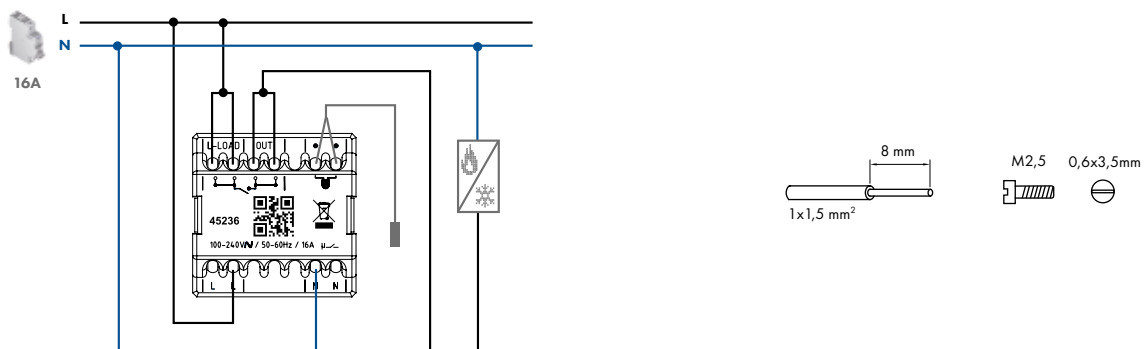

ELECTRIC SHUTTER CONTROLLERS

DESCRIPTION



GENERAL CONTROL WITH IR SENSOR FOR ELECTRIC SHUTTER

- Ref. 45311 S
- MEC Q45 Mechanisms.
- Allows general and individual control of shutters or groups of shutters, either manually or automatically, depending on the pre-programmed time or on the surrounding environmental conditions (wind, sun, etc.) defined by associated external sensors.
- Allows local operation;
- Ability to control remotely using the Multifunctions IR Remote Control Transmitter (Ref. 81900);
- Power reserve: 24 hours;
- Ability to receive sensor signals: **100-240V~, 50/60Hz** (PR1 and PR2);
- 2 Programmable functions (Open/Close);
- "Stand-By" function.



LOCAL CONTROL WITH IR SENSOR FOR ELECTRIC SHUTTERS

- Ref. 45312 S
- MEC Q45 Mechanisms.
- Allows individual control of shutters.
- Allows local operation;
- Ability to control remotely using the Multifunctions IR Remote Control Transmitter (Ref. 81900).

OPERATION

- Push button to raise/lower electric shutter.
- Programme two operations for every 24h (only with the General Control).

CHARACTERISTICS

- **100-240V~, 50/60Hz** - 5A (cosφ = 1).
- Consumption: < 0,5W.
- Standby consumption: < 0,15W.
- Ability to control locally (Local Control) or remotely using the Multifunctions IR Remote Control Transmitter (Ref. 81900).
- Outputs: NO.
- Potential-free output contact.
- Open and Close time: 90 seconds.

DIMENSIONS (mm)

Ref. 45311 S

Ref. 45312 S

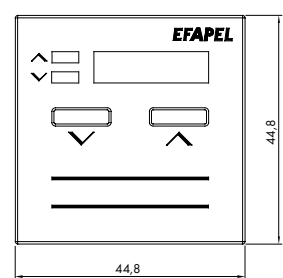
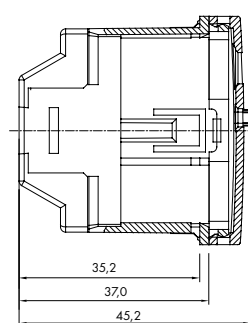
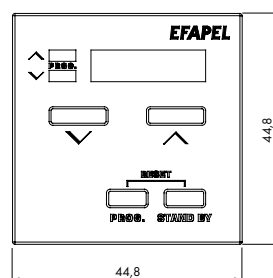
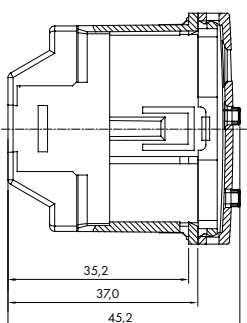

ELECTRIC SHUTTER CONTROLLERS

CONNECTION DIAGRAMS

■ CENTRALISED ELECTRIC SHUTTER INSTALLATION – WITH ELECTRIC SHUTTER CONTROLLERS

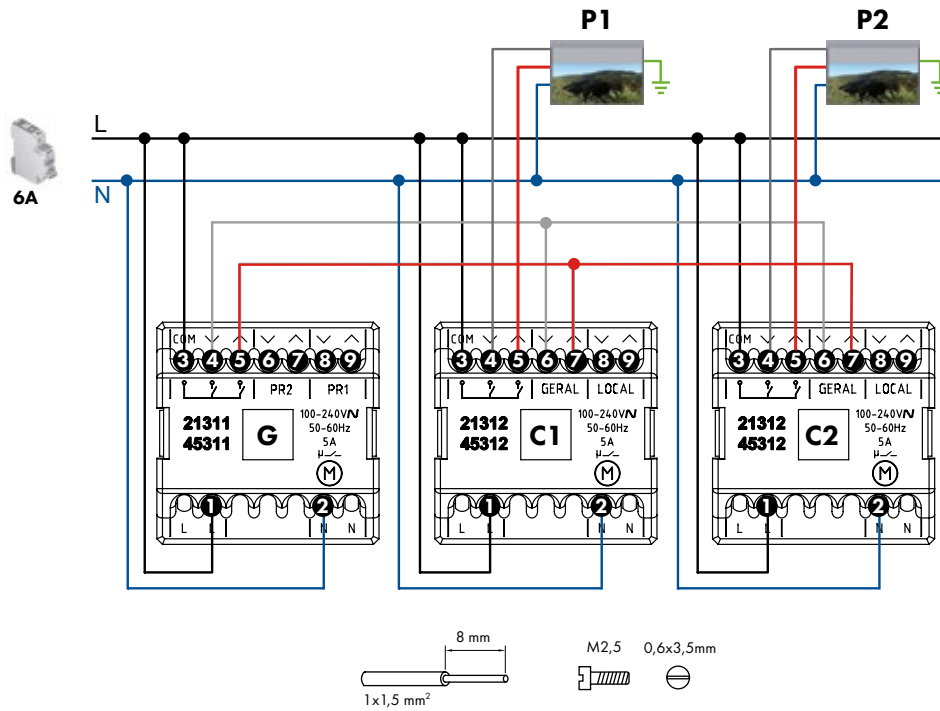

GENERAL CONTROL (G)

1. Device Power (Line)
2. Device Power (Neutral)
3. Output power (Line)
4. Local Control Output - Lower
5. Local Control Output - Raise
6. Priority signal input 2 (100-240V~) - Lower
7. Priority signal input 2 (100-240V~) - Raise
8. Priority signal input 1 (100-240V~) - Lower
9. Priority signal input 1 (100-240V~) - Raise

LOCAL CONTROL (C1), (C2), ...

1. Device Power (Line)
2. Device Power (Neutral)
3. Motor Power (Line)
4. Motor Output - Lower
5. Motor Output - Raise
6. General Control signal Input - Lower
7. General Control signal input - Raise
8. Local Control signal inputs (additional) - Lower
9. Local Control signal inputs (additional) - Raise

INPUT OPERATION (E. G. LOWER ▼)

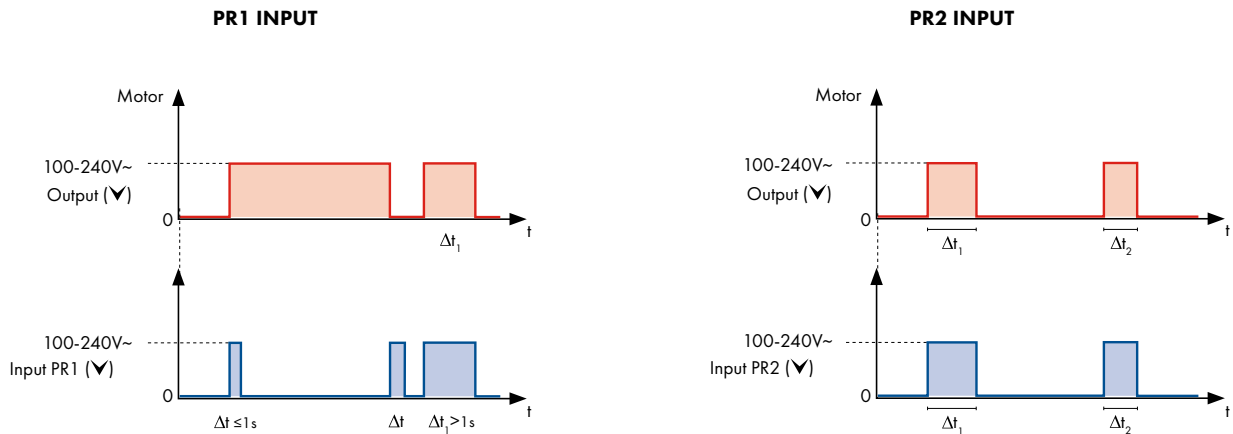

**Note:** Orders given by direct pressing on the device buttons (▲ ▼) or by devices connected to the priority 1 inputs (Local / PR1), cancel the orders received on the priority 2 inputs (General / PR2).

RELAYS FOR ELECTRIC SHUTTER CONTROLLERS

DESCRIPTION



**AUTOMATIC RELAY FOR ELECTRIC SHUTTER CONTROL**

■ Ref. 81512

- It allows general and local control of a group of shutters.
- Can be installed in switchgear or a junction box next to the electric shutter boxes or in a deep box behind the control gear.
- **Timed.**



**PUSH RELAY FOR ELECTRIC SHUTTER CONTROL**

■ Ref. 81511

■ **Compatible only with Double Switches and Double Push-Button Switch for Electric Shutters Control for Multiple Points (Ref. 45283 S).**

- It allows general and local control of a group of shutters.
- Can be installed in the device box or in a junction box next to the electric shutter boxes or in a deep box behind the control gear.
- **Non-timed.**

OPERATION

- Press the relevant buttons to raise/lower electric shutters

CHARACTERISTICS

Ref. 81512

- 230V~ - 50Hz - 6A.
- Consumption: < 1W.
- Time to open and close: 90 seconds.
- Protection from two simultaneous commands - Electric Locking guaranteed by Relay (Ref. 81512).

Ref. 81511

- 230V~ - 50Hz - 6A.
- Consumption: < 1W.
- Protection from two simultaneous commands - Locking
- Device guaranteed by the association of the Relay (Ref. 81511) with the Double Push-Button Switch for Electric Shutters Control for Multiple Points (Ref. 45283 S).

DIMENSIONS (mm)

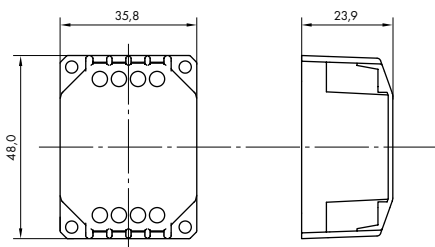

INPUT OPERATION (E. G. LOWER √)

Ref. 81512

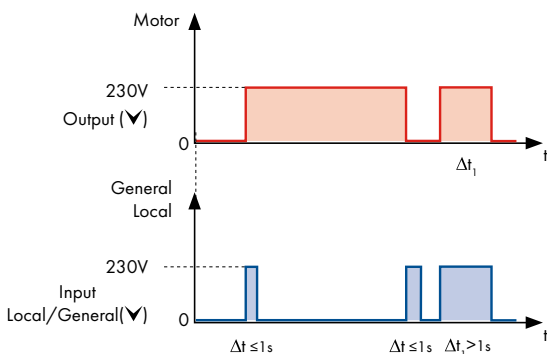

Ref. 81511

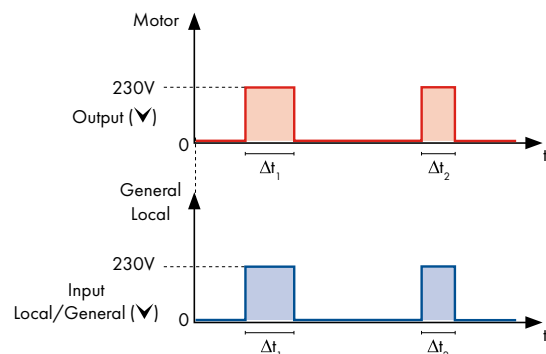

RELAYS FOR ELECTRIC SHUTTER CONTROLLERS

CONNECTION DIAGRAMS

■ CENTRALISED ELECTRIC SHUTTER INSTALLATION - WITH LOCAL CONTROL MODULE WITH IR SENSORS (Ref. 81512)

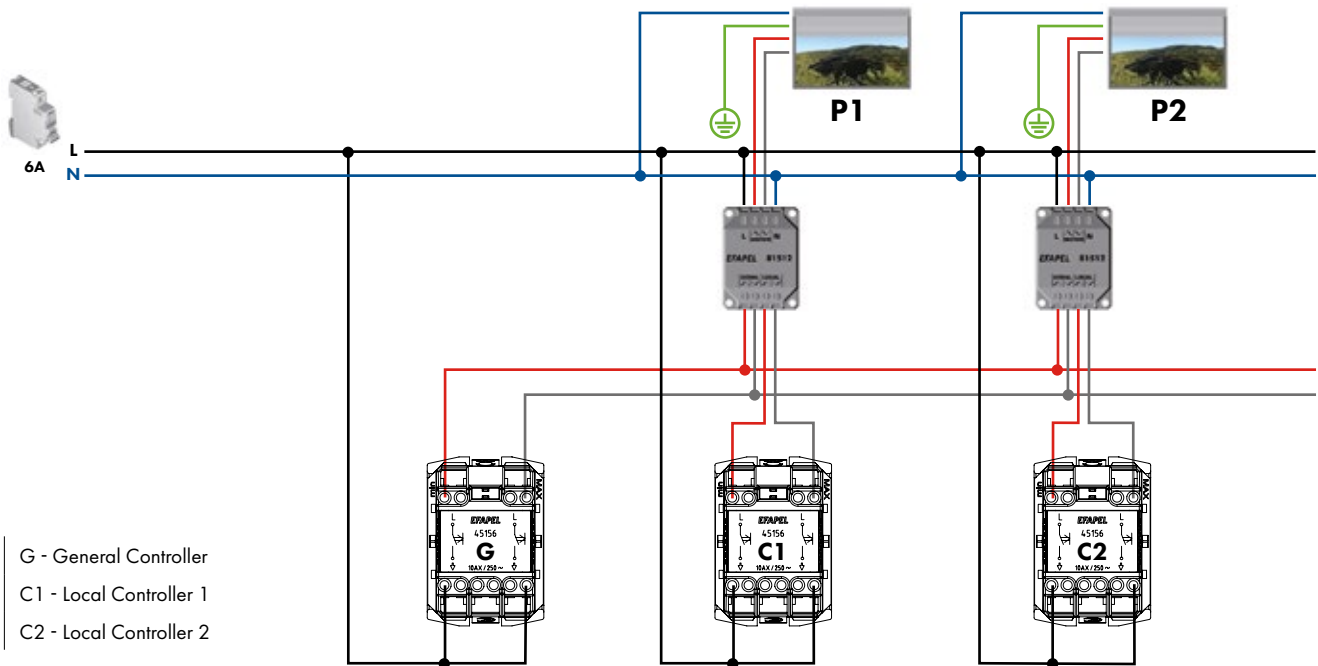

G - General Controller  
 C1 - Local Controller 1  
 C2 - Local Controller 2

**Note:** Protection from two simultaneous raise and lower commands using the same or different devices is guaranteed by the relay software.

■ CENTRALISED ELECTRIC SHUTTER INSTALLATION - GENERAL CONTROL MODULE WITH IR SENSORS (Ref. 81511)

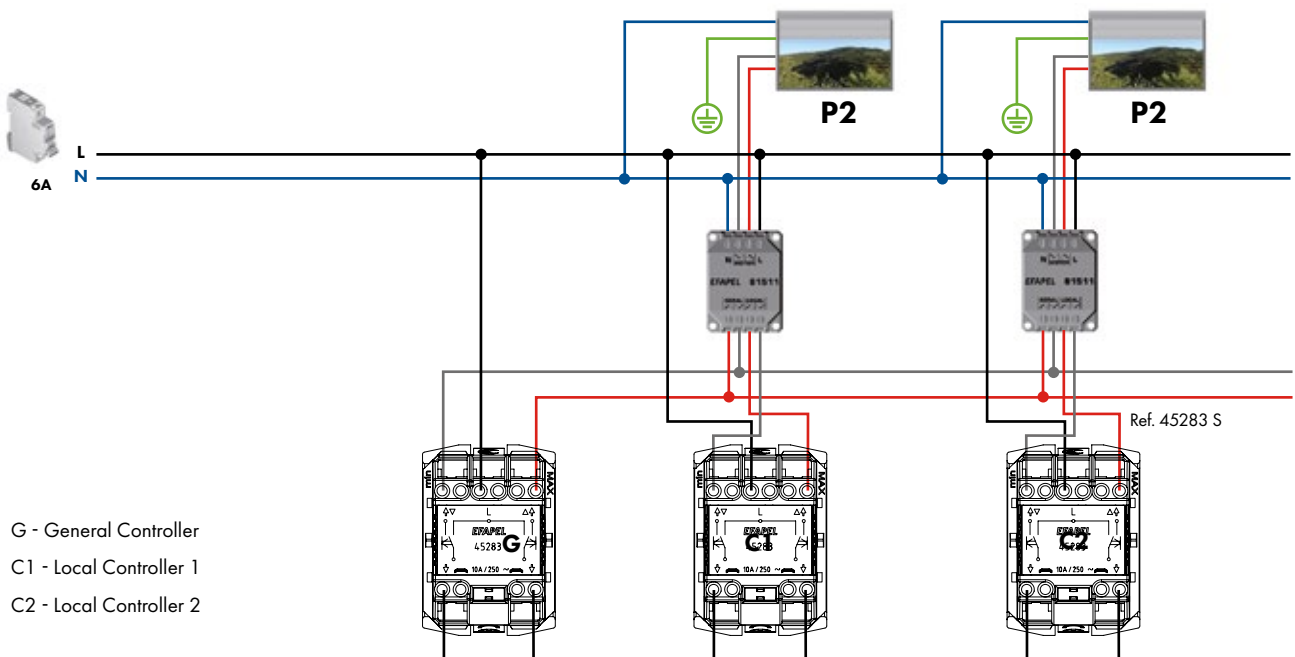

G - General Controller  
 C1 - Local Controller 1  
 C2 - Local Controller 2

**Notes:**

- To raise / lower all shutters it is necessary to keep the key pressed .
- Protection from two simultaneous commands, raise and lower, using the same or different devices is ensured by the combination of the mechanism (Ref. 45283 S) and Relay (Ref. 81511), which is why this relay only works with this mechanism.

■ LOCAL CONTROL MODULE WITH IR SENSORS (Ref. 81512)

- N - Neutral
- L - Line
- ▲ - Motor output - Raise
- ▼ - Motor output - Lower
- GENERAL - Input from General Controller
- LOCAL - Input from Local Controller

■ GENERAL CONTROL MODULE WITH IR SENSORS (Ref. 81511)

- N - Neutral
- L - Line
- ▲ - Motor output - Raise
- ▼ - Motor output - Lower
- GENERAL - Input from General Controller
- LOCAL - Input from Local Controller

HDMI SOCKET

DESCRIPTION



- **Ref. 45435 S** - HDMI Sockets with Connector - 1 Module.
- **Ref. 45436 S** - HDMI Socket with Screw Connection - 2 Modules.  
High definition audio and video data passing sockets between any transmitter (computer, DVD, ...) and a terminal (TV, LCD, Video projector, ...).
- **MEC Q45** Mechanisms.

CHARACTERISTICS

	Ref. <b>45435 S</b>	Ref. <b>45436 S</b>
Technical Thermoplastic Mechanisms - non-conductive resistant material		
Connection	Via the cord (Female Connector)	Screws
Maximum distance between HDMI sockets	10 metres	5 metres
Maximum resolution	1080p	1080p
Connectors	Type 1.4 Version E	Type 1.4 Version E

DIMENSIONS (mm)

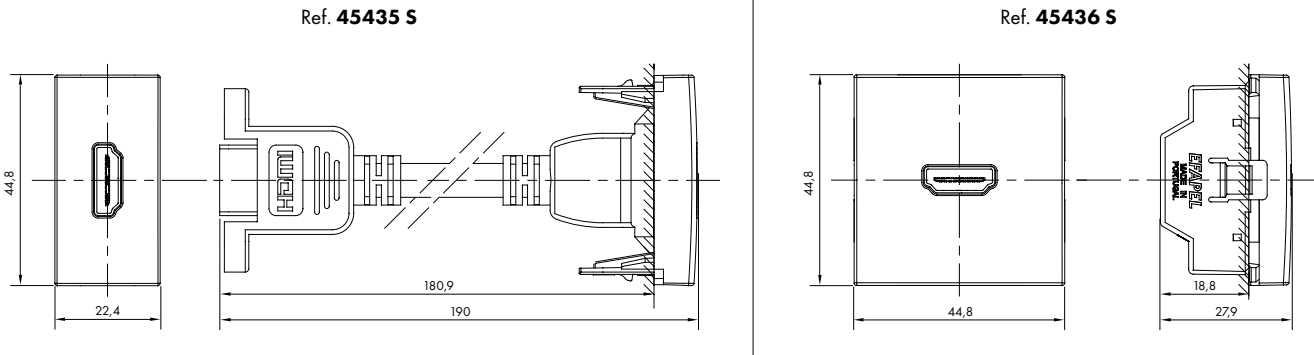

CONNECTION DIAGRAMS

Ref. **45436 S**

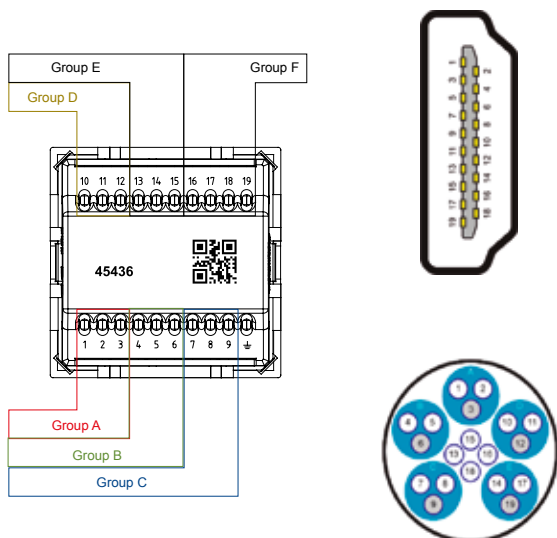

Pin	Pin	Group
Pin 1	TMDS Data2+	Group A / Red Group
Pin 2	TMDS Data2 Data Shield	
Pin 3	TMDS Data2-	
Pin 4	TMDS Data1+	Group B / Green Group
Pin 5	TMDS Data1 Data Shield	
Pin 6	TMDS Data1-	
Pin 7	TMDS Data0+	Group C / Blue Group
Pin 8	TMDS Data0 Data Shield	
Pin 9	TMDS Data0-	
Pin 10	TMDS Clock+	Group D / Brown Group
Pin 11	TMDS Clock Data Shield	
Pin 12	TMDS Clock-	
Pin 13	CEC	Group E
Pin 14	Reserved, HEC Data - (Optional, 1.4+ with Ethernet channel)	
Pin 15	SCL (DDC)	
Pin 16	SDA (DDC)	
Pin 17	DDC/CEC Ground	
Pin 18	+5V Power	Group F / Remaining Wires without Group
Pin 19	Hot Plug Detect, HEC Data + (Optional, 1.4+ with Ethernet channel)	

USB | VGA | RCA DATA SOCKET

DESCRIPTION



- **Ref. 45437 S** - USB Data Socket - 1 Module. Data transfer socket via USB connection.
- **Ref. 45430 S** - VGA socket - 2 Modules - Video data passing socket between any transmitter (computer, DVD, ...) and a terminal (TV, LCD, Video projector, ...).
- **Ref. 45580 S** - RCA / Stereo / Video Socket - 1 Module - Audio and video data passing sockets between any transmitter (computer, DVD, ...) and a terminal (TV, LCD, Video projector, ...).
- **MEC Q45** Mechanisms.

CHARACTERISTICS

	Ref. 45437 S	Ref. 45430 S	Ref. 45580 S
Technical Thermoplastic Mechanisms - non-conductive resistant material			
Connection	Screw	Screw	Screw
Maximum distance between sockets	5 metres	15 metres	20 metres
Maximum speed	12 Mbit/s	not applicable	not applicable

DIMENSIONS (mm)

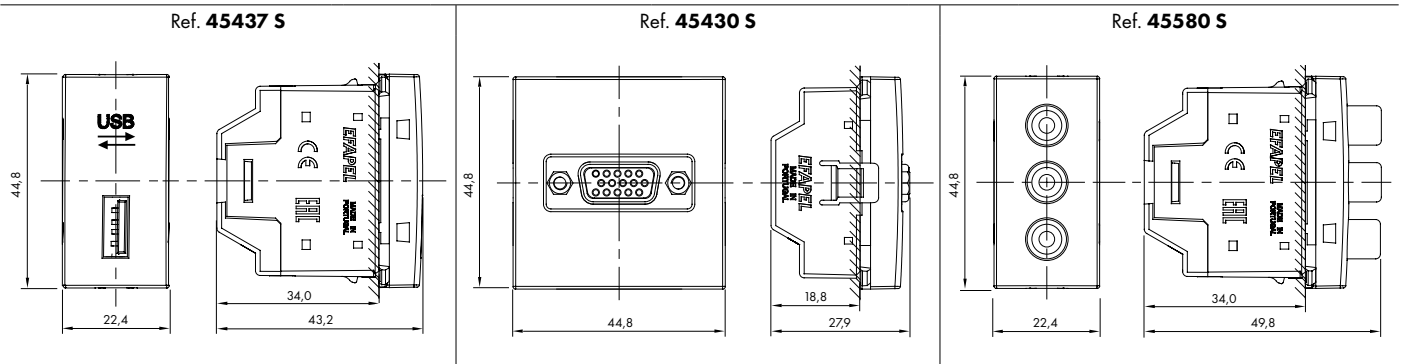

CONNECTION DIAGRAMS

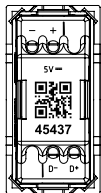

Pin	
+	VBUS 5VDC
-	GROUND
D+	DATA +
D-	DATA -

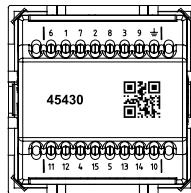

Pin	
1	RED COAX
2	GREEN COAX
3	BLUE COAX
4	ORANGE (ID BIT 2 - NC)
5	RED (GND)
6	RED BRAID
7	GREEN BRAID
8	BLUE BRAID
9	WHITE (KEY)
10	BLUE (GND)
11	BROWN (ID BIT 0 - GND)
12	YELLOW (ID BIT 1 - SDA)
13	GREY (HORIZONTAL SYNCHRONIZATION)
14	GREEN (VERTICAL SYNCHRONIZATION)
15	BLACK (ID BIT 3 - SCL)
16	SHIELD (GROUND)

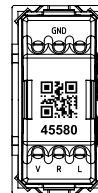

Pin	
V	VIDEO CABLE
R	RIGHT AUDIO SIGNALS
L	LEFT AUDIO SIGNALS
GND	GROUND

RJ45 UTP CAT. 6A / 6 CONNECTORS

DESCRIPTION



**RJ45 CAT. 6A UTP CONNECTOR (500 MHz) - (Blue)**

- Ref. 82021 - MEC Q45 Mechanisms;
- Unshielded;
- Universal **KEYSTONE** fitting.



**RJ45 CAT. 6 UTP CONNECTOR (250 MHz) - (Red)**

- Ref. 21978 - MEC Q45 Mechanisms;
- Unshielded;
- Universal **KEYSTONE** fitting.



\*PoE - Power Over Ethernet

CHARACTERISTICS

- Reduced size;
- Quick assembly;
- **Tool-free** connection (connectors with self-stripping contacts);
- Robust and secure connection, through an effective conductors crimping system;
- Cable compatibility: 23-26 AWG;
- Universal **KEYSTONE** fitting;
- Compatible with high density RACK (21978 - RACK Cat. 6 and 82021 - RACK Cat. 6A);
- Compatible with color coding EIA/TIA 568A and EIA/TIA 568B;
- Full **PoE** compliance - in accordance with IEC 60512-99-002 Standard: **Type 4 / Power Class 8**;
- In accordance with TIA 568.2-D, ISO 11801, EN 50173-1 and IEC 60603-7-4 Standards; Tool-free connection (connectors with self-stripping contacts).

DIMENSIONS (mm)

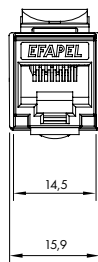
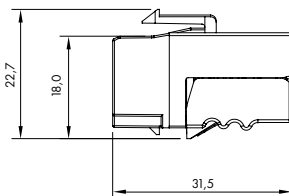
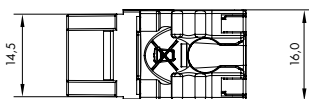

INSTALLATION



CONNECTIONS

TERMINALS	EIA / TIA 568A		EIA / TIA 568B	
	PAR	CABLE COLOR	PAR	CABLE COLOR
PIN 5	1	White / Blue	1	White / Blue
PIN 4		Blue		Blue
PIN 1	2	White / Green	2	White / Orange
PIN 2		Green		Orange
PIN 3	3	White / Orange	3	White / Green
PIN 6		Orange		Green
PIN 7	4	White / Brown	4	White / Brown
PIN 8		Brown		Brown



RADIO / TV / SATELLITE SOCKETS

DESCRIPTION



RADIO / TV / SATELLITE SOCKETS

■ MEC Q45 Mechanisms.

CHARACTERISTICS

- A - Derivation attenuation
- B - Return Losses
- C - Insulation between outputs

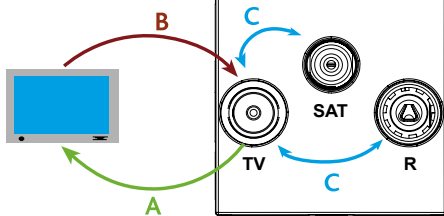

DIMENSIONS (mm)

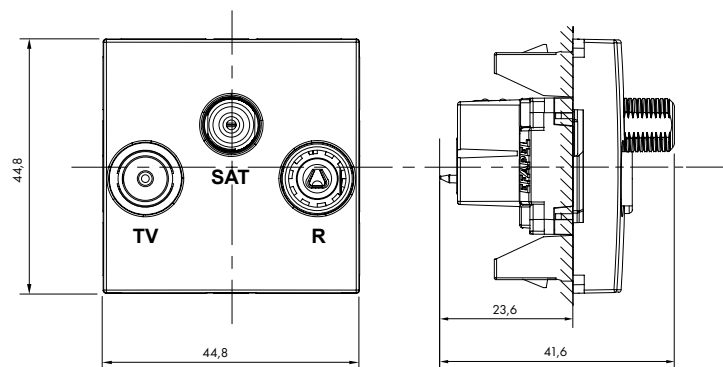

SOCKETS TYPE

TYPOLOGY		REF.	RADIO	TV	SAT
STAR CONNECTION	<p>Star Connection</p>	45543 S	⊖	⊙	⊕
	<p>Star Connection</p>	45533 S	⊖	⊙	
SERIES CONNECTION	<p>Terminal</p>	45554 S	⊖	⊙	
	<p>Passage Terminal</p>	45555 S	⊖	⊙	⊕
	<p>Passage</p>	45564 S	⊖	⊙	
	<p>Passage Terminal</p>	45565 S	⊖	⊙	⊕

RADIO / TV / SATELLITE SOCKETS

■ R - TV - SAT SOCKETS (IMPEDANCE OF 75 OHM)

LINEAL	OUTPUTS		DERIVATION LOSSES (DB) <sup>A</sup>										INSERTION LOSSES dB	INSULATION BETWEEN OUTPUTS dB	RETURN LOSSES dB	DC CURRENT PASSAGE CONNECTOR/ mA (DC)
	CONNECTOR/ OUTPUTS		RETURN	BI	SUB BAND	FM	S. LOW	BIII /DAB	S. HIGH HYPER	UHF	SAT					
REF.			4-47 MHz	47-68 MHz	68-80 MHz	84-108 MHz	112-174 MHz	174-230 MHz	230-446 MHz	470-862 MHz	950-2150 MHz	2150-2400 MHz		C	B	
STAR 45543 S NQ 2b	IEC MALE	TV	0,8	1,0	0,8	0,8	0,8	0,8	0,8	2,0	--	--	--	>20	>18	--
	IEC FEMALE	R	17,4	17,4	17,4	17,4	17,4	17,4	17,4	17,4	--	--				--
	F FEMALE	SAT	--	--	--	--	--	--	--	--	2,2	2,6				(SAT-IN) 500mA
TERMINAL 45555 S NQ 2b	IEC MALE	TV	6,2 <sup>+1</sup>	6,2 <sup>+1</sup>	6,2 <sup>+1</sup>	6,2 <sup>+1</sup>	6,0 <sup>+1</sup>	6,2 <sup>+1</sup>	5,8 <sup>+1</sup>	8,6 <sup>+1</sup>	--	--	--	>12	>18	--
	IEC FEMALE	R	15	15	15	15	15	15	15	15	--	--				--
	F FEMALE	SAT	--	--	--	--	--	--	--	--	5,6 <sup>+1</sup>	6,4 <sup>+1</sup>				(SAT-IN) 500mA
PASSAGE 45565 S NQ 2b	IEC MALE	TV	10,0 <sup>+1</sup>	10,0 <sup>+1</sup>	10,0 <sup>+1</sup>	10,0 <sup>+1</sup>	9,6 <sup>+1</sup>	10,0 <sup>+1</sup>	10,0 <sup>+1</sup>	10,0 <sup>+1</sup>	--	--	<3,6	>12	>18	--
	IEC FEMALE	R	20,0 <sup>+1</sup>	20,0 <sup>+1</sup>	20,0 <sup>+1</sup>	20,0 <sup>+1</sup>	20,0 <sup>+1</sup>	20,0 <sup>+1</sup>	20,0 <sup>+1</sup>	20,0 <sup>+1</sup>	--	--				--
	F FEMALE	SAT	--	--	--	--	--	--	--	--	11,0 <sup>+1</sup>	8,6 <sup>+1</sup>				(SAT-IN) 500mA

■ R - TV - SAT SOCKETS (IMPEDANCE OF 75 OHM)

EQUALIZED	OUTPUTS		DERIVATION LOSSES (DB) (dB) <sup>A</sup>										INSERTION LOSSES dB	INSULATION BETWEEN OUTPUTS dB	RETURN LOSSES dB	
	CONNECTOR/ OUTPUTS		RETURN	BI	SUB BAND	FM	S. LOW	BIII /DAB	S. HIGH HYPER	UHF	SAT					
REF.			4-47 MHz	47-68 MHz	68-80 MHz	84-108 MHz	112-174 MHz	174-230 MHz	230-446 MHz	470-862 MHz	950-2150 MHz	2150-2400 MHz		C	B	
STAR 45533 S NQ 2a	IEC MALE	TV	0,2	0,4	0,4	--	1,0	1,0	0,4	0,8	--	--	--	>20	--	
	IEC FEMALE	R	--	--	--	2,0 <sup>+0.3</sup>	--	--	--	--	--	--				
TERMINAL 45554 S NQ 2a	IEC MALE	TV	5,8 <sup>+1</sup>	6,0 <sup>+1</sup>	6,0 <sup>+1</sup>	--	6,0 <sup>+1</sup>	6,0 <sup>+1</sup>	6,0 <sup>+1</sup>	6,4 <sup>+1</sup>	--	--	--	>20	>18	
	IEC FEMALE	R	--	--	--	8,2 <sup>+1</sup>	--	--	--	--	--	--				
PASSAGE 45564 S NQ 2a	IEC MALE	TV	8,2 <sup>+1</sup>	8,2 <sup>+1</sup>	8,2 <sup>+1</sup>	--	8,0 <sup>+1</sup>	7,4 <sup>+1</sup>	7,4 <sup>+1</sup>	8,4 <sup>+1</sup>	--	--	1,6 <sup>+0.5</sup>	>20	>18	
	IEC FEMALE	R	--	--	--	8,8 <sup>+1</sup>	--	--	--	--	--	--				

USB POWER SOCKETS

DESCRIPTION



- Ref. 45384 S - Double USB Charger Type A with 20° Outputs - 2 Modules - 2400mA.
- Ref. 45439 S - Double USB Charger Type A - 2 Modules - 2100mA.
- Ref. 45383 S - USB Charger Type A - 1 Module - 1500mA.
- Allows you to power / charge loads powered via USB port, such as mobile phones / smartphones, tablets, powerbanks, etc.
- MEC Q45 Mechanisms.

CHARACTERISTICS

	Ref. 45384 S	Ref. 45439 S	Ref. 45383 S
Technical Thermoplastic Mechanisms - non-conductive resistant material			
Input voltage	100-240V~ - 50/60Hz	100-240V~ - 50/60Hz	100-240V~ - 50/60Hz
Output voltage	5V---	5V---	5V---
Input maximum current	2,4A	2,1A	1,5A
Efficiency	80%	78%	80%
Standby Consumption	< 0,1W	< 0,2W	< 0,1W
Output	2xUSB A type	2xUSB A type	1xUSB A type

DIMENSIONS (mm)

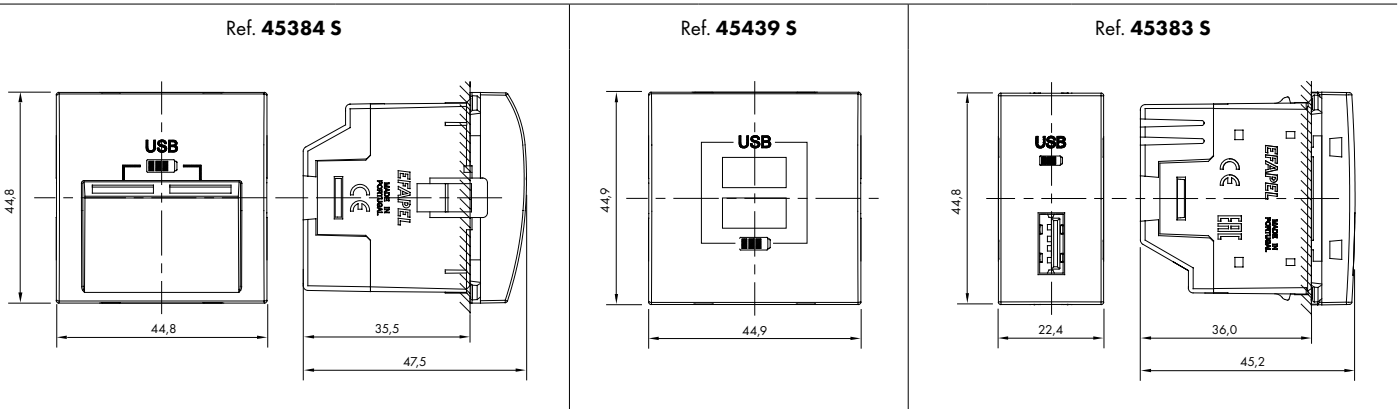

CONNECTION DIAGRAMS

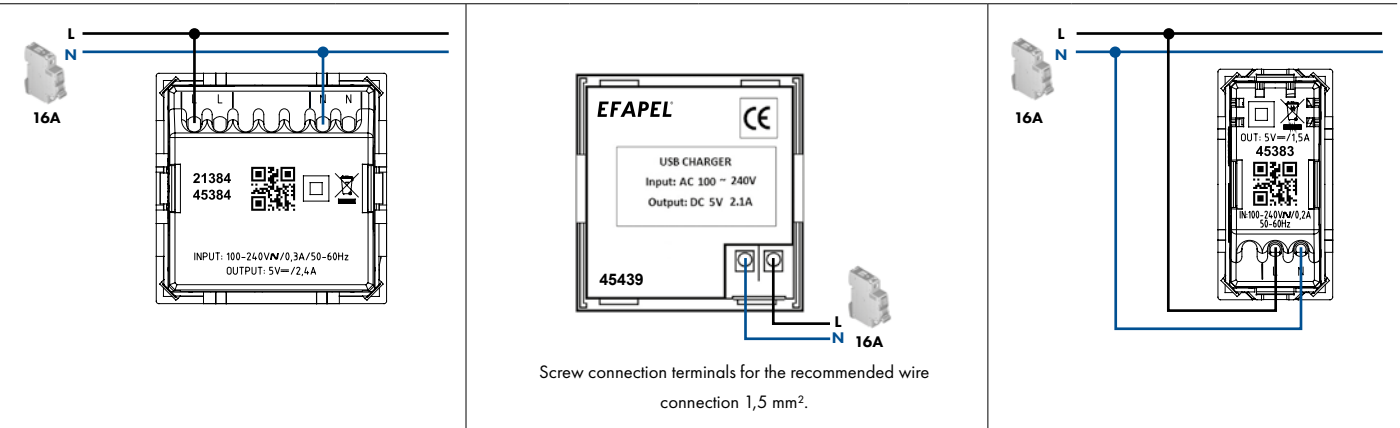

MEC Q45 - POWER SOCKETS

DESCRIPTION



- **MEC Q45** Mechanisms.
- Installation:
  - Flush-mounted (Installed in apparatus box);
  - Surface (Installed in Surface Box);
  - Technical Trunking:
    - Mini Cable Trunking (Using the Surface Box with trunking adaptor);
    - Distribution Trunking (Using the **MEC Q45** Modular Adapter).
- Available in the colours: **BR** - White (RAL 9003), **BM** - Matte White, **AL** - Aluminium, **PM** - Matte Black, **VM** - Red, **LR** - Orange and **VD** - Green.

CHARACTERISTICS

- **Technical Thermoplastic Mechanisms - non-conductive resistant material.**
- **Power Sockets**
  - **Schuko Socket:**
    - 16A - 250V~ - Connections with **screw terminals** or **screwless terminals**. It allows the usage of rigid and flexible cable.
    - In accordance with IEC 60884-1; DIN VDE 0620-1 Standards.
  - **French Socket:**
    - 16A - 250V~ - Connections with **screw terminals** or **screwless terminals**. It allows the usage of rigid and flexible cable.
    - In accordance with IEC 60884-1; NF C 61-314 Standards.

DIMENSIONS (mm)

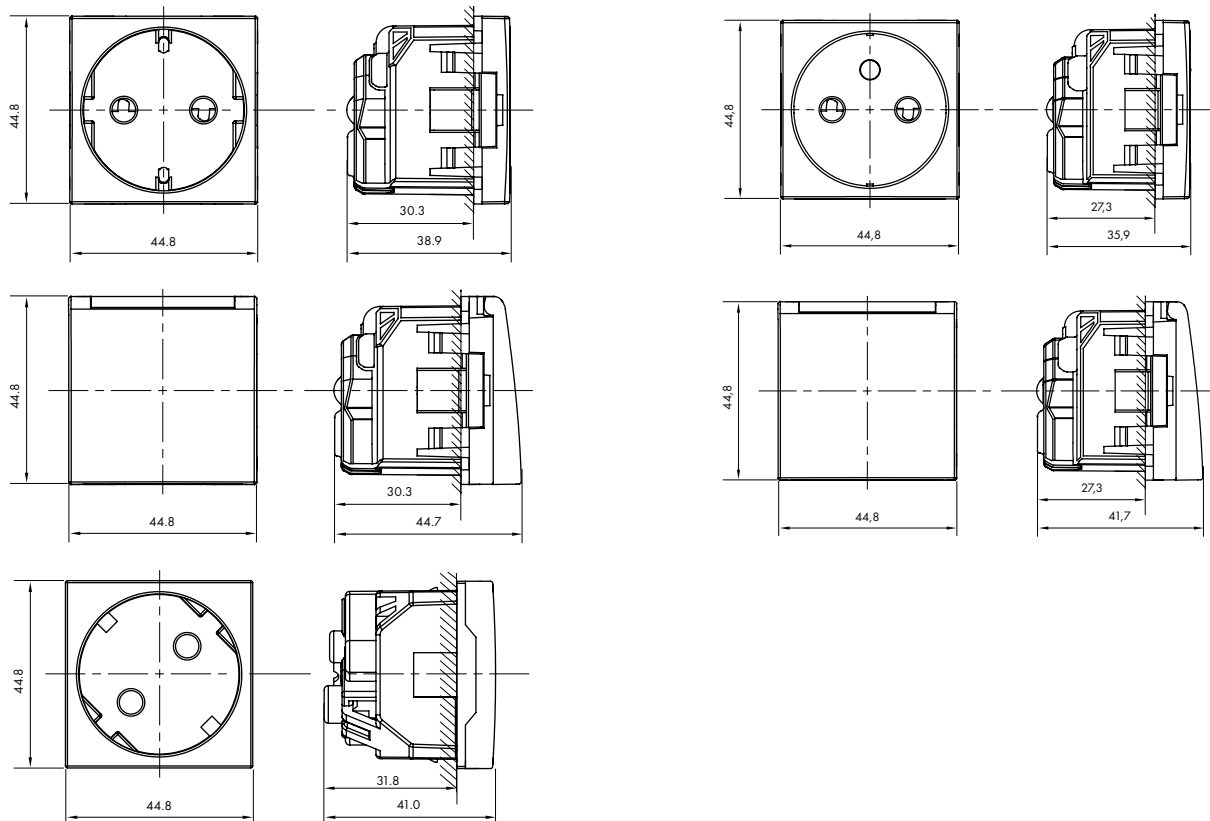

MEC Q45 - POWER SOCKETS

DESCRIPTION



- **MEC Q45** Mechanisms of 1, 2 and 3 modules.
- Installation:
  - Flush-mounted (Installed in apparatus box);
  - Surface (Installed in Surface Box);
  - Technical Trunking:
    - Mini Cable Trunking (Using the Surface Box with trunking adaptor);
    - Distribution Trunking (Using the **MEC Q45** Modular Adapter).
- Available in the colors **BR** - White (RAL 9003), **BM** - Matte White, **AL** - Aluminium, **PM** - Matte Black and **VM** - Red.

CHARACTERISTICS

- **Technical Thermoplastic Mechanisms - non-conductive resistant material.**
- **Power Sockets**
  - **Euro-American Sockets:**
    - 15A - 127V~/16A - 250V~.
    - In accordance with ANSI; NEMA WD-6 (Figure 5-15) and IEC 60884-1 Standards.
  - **American NEMA Socket:**
    - 15A - 127V~.
    - In accordance with SASO 2204 and NEMA WD-6 (Figure 5-15) Standards.
  - **Double American Socket:**
    - 15A - 127V~.
    - In accordance with SASO 2204 and NEMA WD-6 (Figure 5-15) Standards.
- **Italian Socket:**
  - 10A - 16A - 10A/16A - 250V~.
  - Screw terminals connectors.
  - In accordance with IEC 60884-1 (CEI 23-50) Standard.
- **Brazilian Socket:**
  - 10A - 20A - 250V~.
  - In accordance with IEC 60884-1 (ABNT NBR 14136) Standard.

DIMENSIONS (mm)

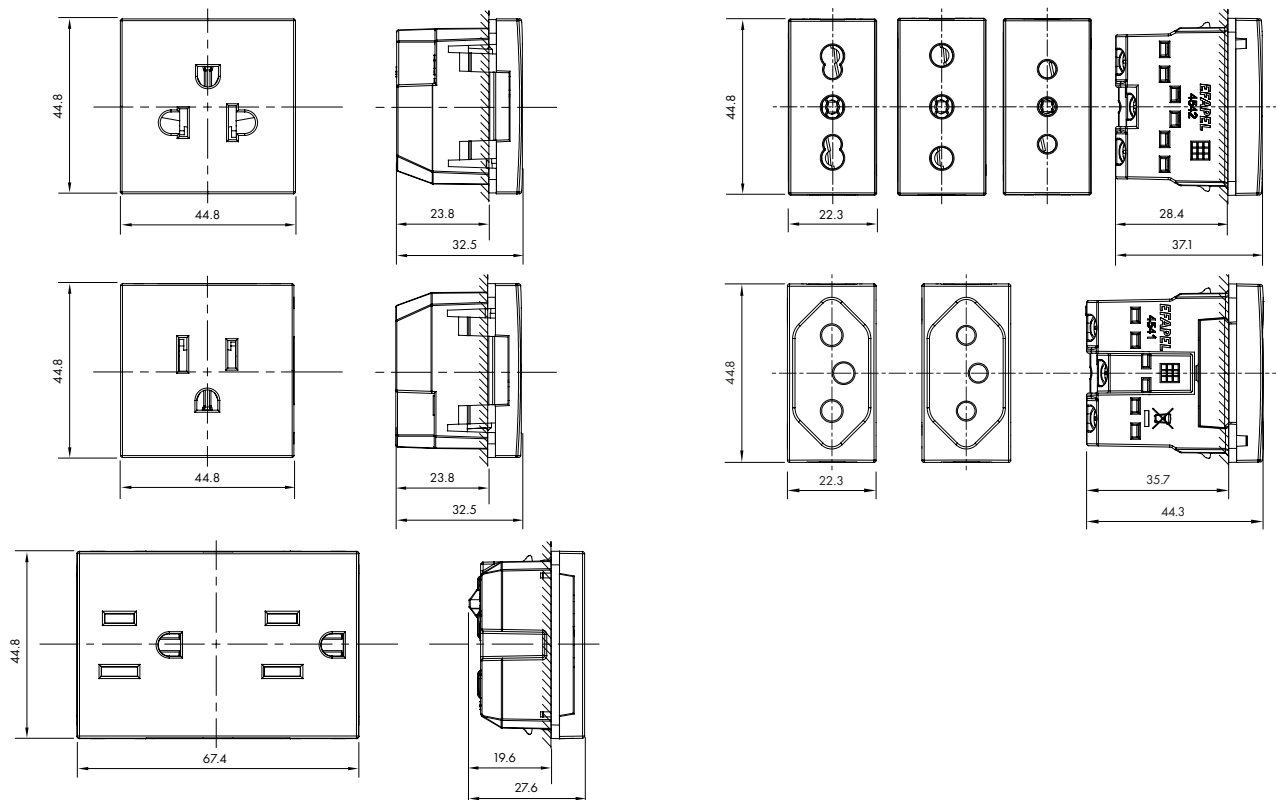

DOUBLE AMERICAN GFCI SOCKET 2P+T 127V 20A/15A GFCI

DESCRIPTION

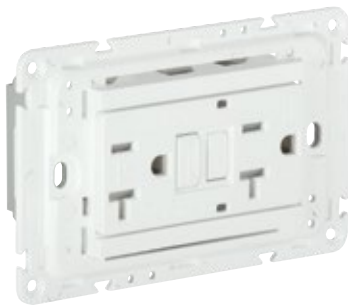

DOUBLE AMERICAN GFCI SOCKET 2P+T 127V 20A/15A GFCI

- Ref. 41148/41149 X - MEC Q45 Mechanisms:
  - Ref. 41148 X - American standard 20A socket with shutter and ground fault circuit interrupter
  - Ref. 41149 X - American standard 15A socket with shutter and ground fault circuit interrupter
- Installation:
  - Flush-mounted (Installed in apparatus box - 3 modules);
  - Surface (Installed in Surface Box - 3 modules);
  - Cable Trunking:
    - Mini Cable Trunking (with Surface Box - 3 modules).
- Available in the colors: **BL** - White and **NG** - Black.

CHARACTERISTICS

- Power: 127V~ - 60Hz;
- Current: 20A/15A;
- Tripping current: 5±1 mA;
- Tripping time: 0,025 seg;
- Cut-off power: 10kA/6kV;
- Operating temperature: -35°C to 65°C;
- UL943-2006 Standard Class A;
- ANSI/NEMA: 5-20R, WD6.

OPERATION

- GREEN LED ON - Operating OK;
- RED LED BLINKING - Carrying out differential protection SELF TEST, carried out every 1-10 minutes;
- RED LED ON - ALARM on / End of Life (no differential protection /ground protection verification / replace GFCI).

FRONT VIEW

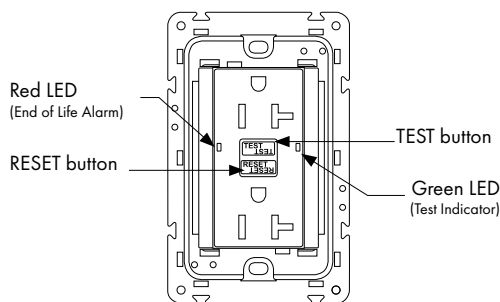

REAR VIEW

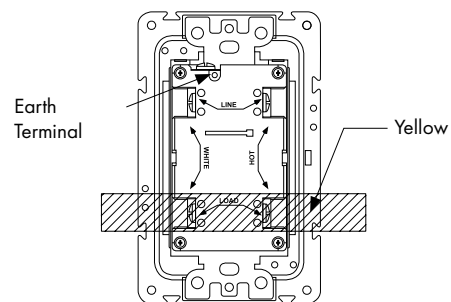

DIMENSIONS (mm)

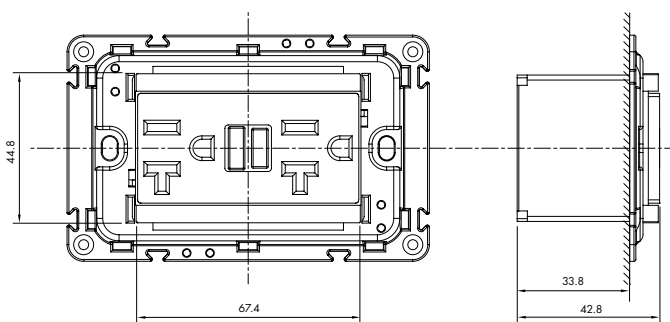

MONTHLY PROCEDURE TEST

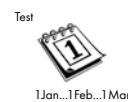
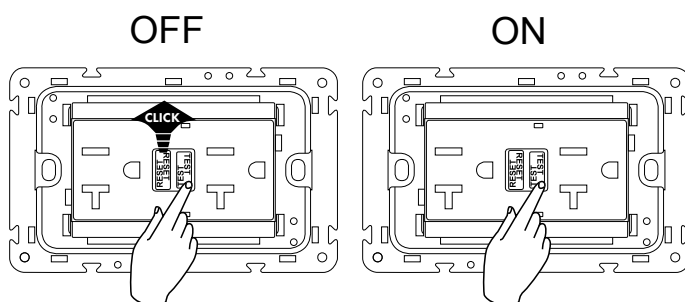

Month	01	02	03	04	05
Year					
2020	√	√			
2021					
2022					
2023					
2024					

Test Record

EUROPEAN MATRIX FRAMES - DIMENSIONS (mm)

SINGLE

REF. 42910 T - ① BASE - AQUARELLA | ② LYRA, LIGNA, METALLUM)

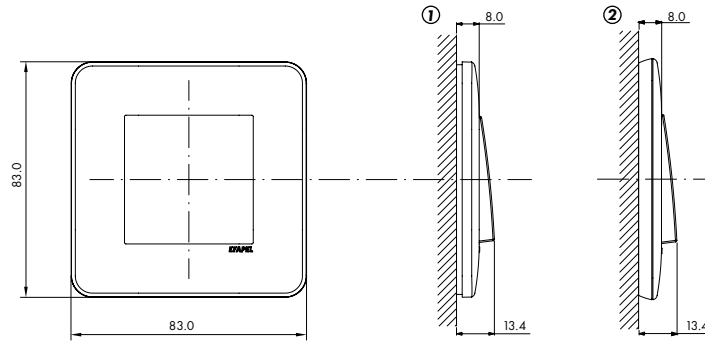

DOUBLE

REF. 42920 T - ① BASE - AQUARELLA | ② LYRA, LIGNA, METALLUM)

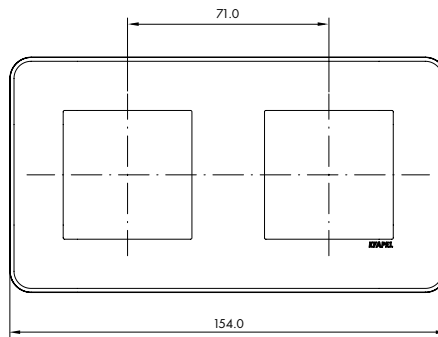

TRIPLE

REF. 42930 T - ① BASE - AQUARELLA | ② LYRA, LIGNA, METALLUM)

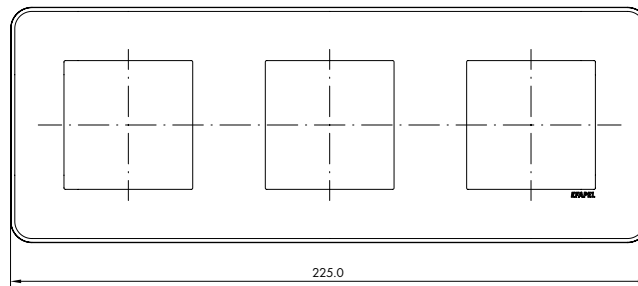

4-GANG

REF. 42940 T - ① BASE - AQUARELLA | ② LYRA, LIGNA, METALLUM)

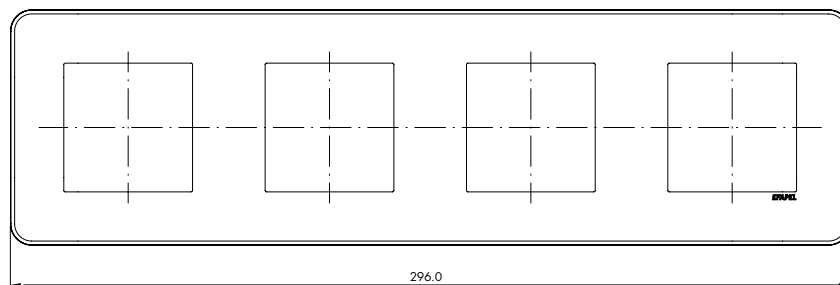

EUROPEAN MATRIX FRAMES - DIMENSIONS (mm)

SINGLE

REF. 42910 T - (CROMA)

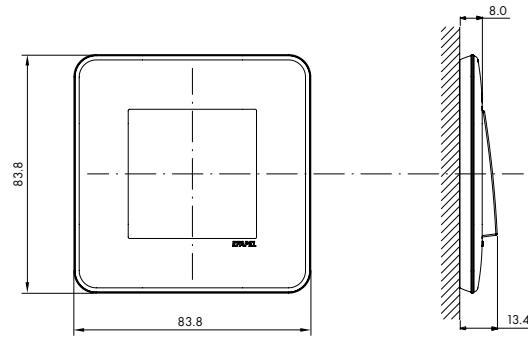

DOUBLE

REF. 42920 T - (CROMA)

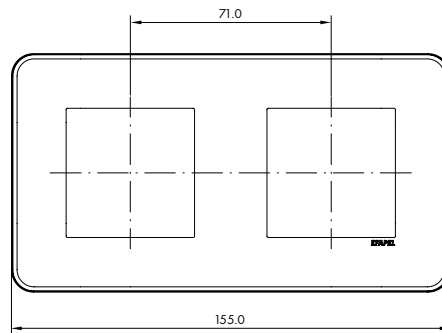

TRIPLE

REF. 42930 T - (CROMA)

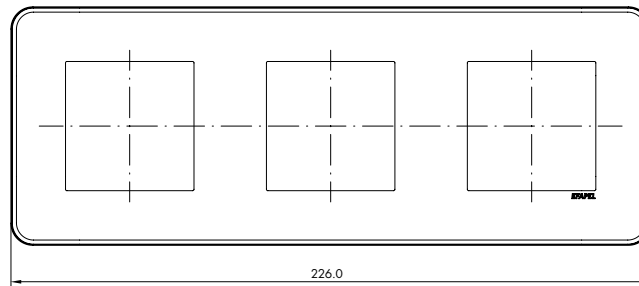

4-GANG

REF. 42940 T - (CROMA)

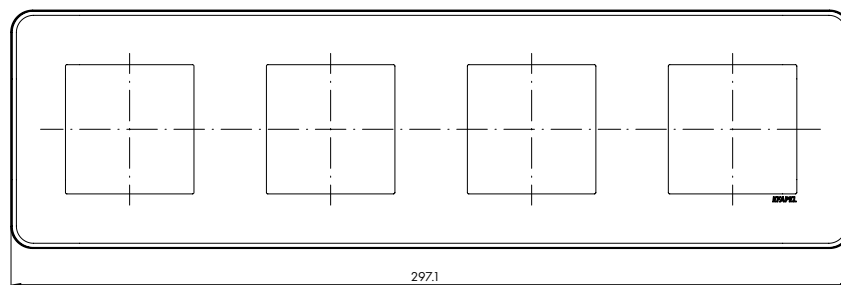



ITALIAN MATRIX FRAMES - DIMENSIONS (mm)

1 MODULE

REF. 41913 T (010) - ① BASE - AQUARELLA

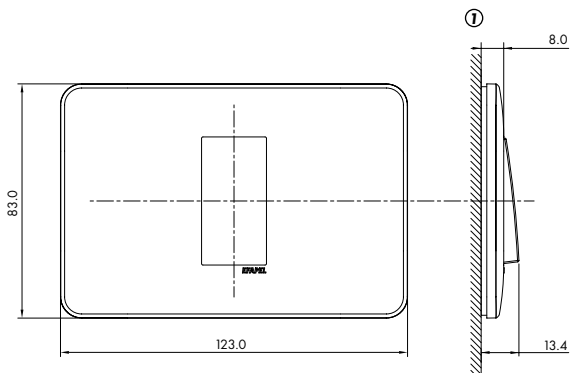

3 MODULES

REF. 41916 T - ① BASE - AQUARELLA | ② LYRA, LIGNA, METALLUM

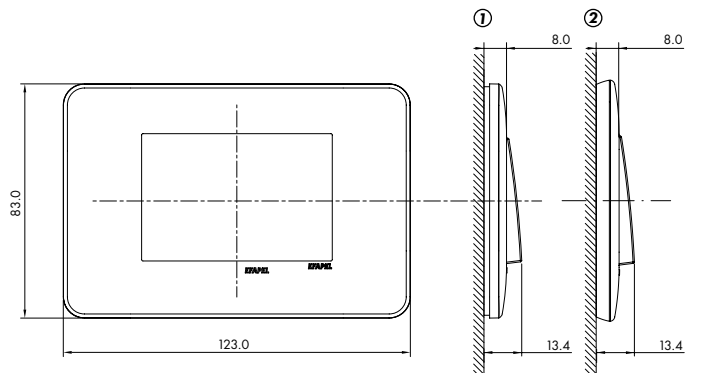

2 MODULES

REF. 41914 T - ① BASE - AQUARELLA

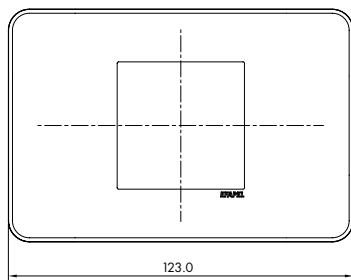

4 MODULES

REF. 41917 T - ① BASE - AQUARELLA | ② LYRA, LIGNA, METALLUM

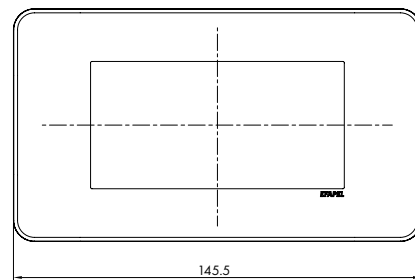

2 MODULES

REF. 41915 T (101) - ① BASE - AQUARELLA

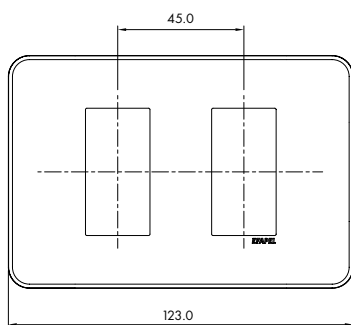

6 MODULES

REF. 41918 T - ① BASE - AQUARELLA | ② LYRA, LIGNA, METALLUM

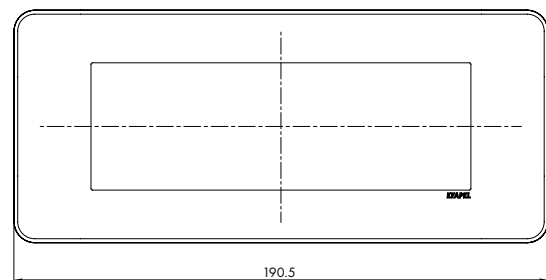

ITALIAN MATRIX FRAMES - DIMENSIONS (mm)

3+3 MODULES

REF. 41926 T - ① BASE - AQUARELLA | ② LYRA, LIGNA, METALLUM

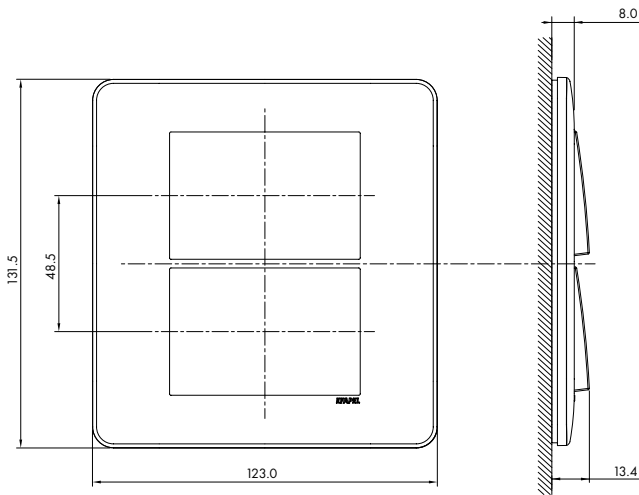

3 MODULES

REF. 41916 T - (CROMA)

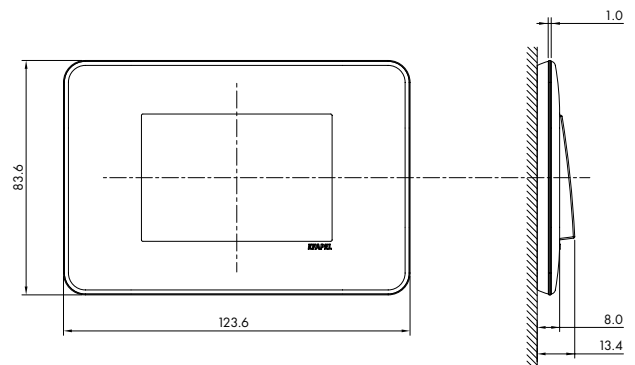

3 MODULES

REF. 41916 T - (CRYSTAL)

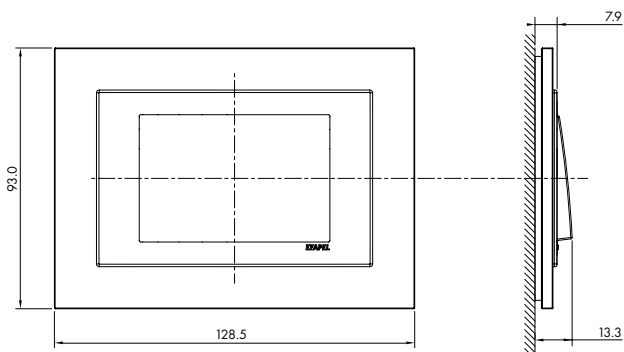

4 MODULES

REF. 41917 T - (CROMA)

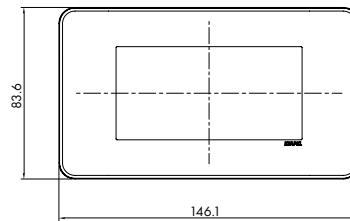

6 MODULES

REF. 41918 T - (CROMA)

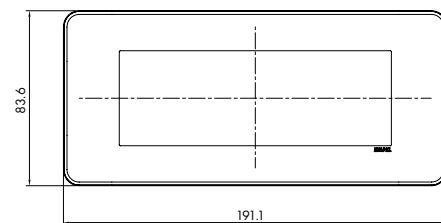

3+3 MODULES

REF. 41926 T - (CRYSTAL)

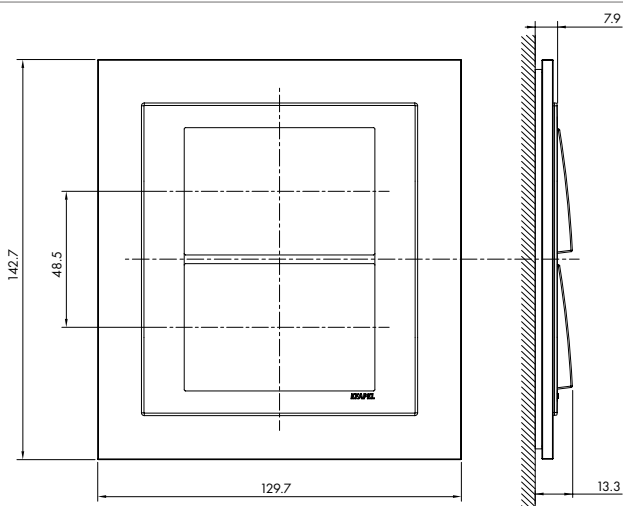

3+3 MODULES

REF. 41926 T - (CROMA)

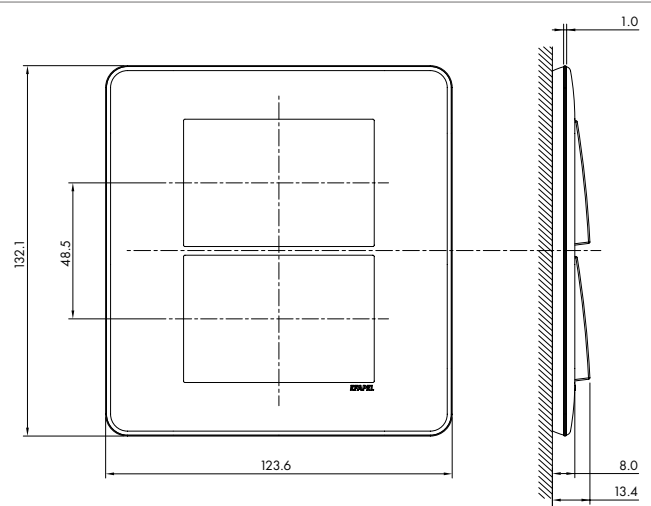

EUROPEAN MATRIX SUPPORT FRAMES - DIMENSIONS (mm)

SINGLE WITHOUT CLAWS

REF. 42993

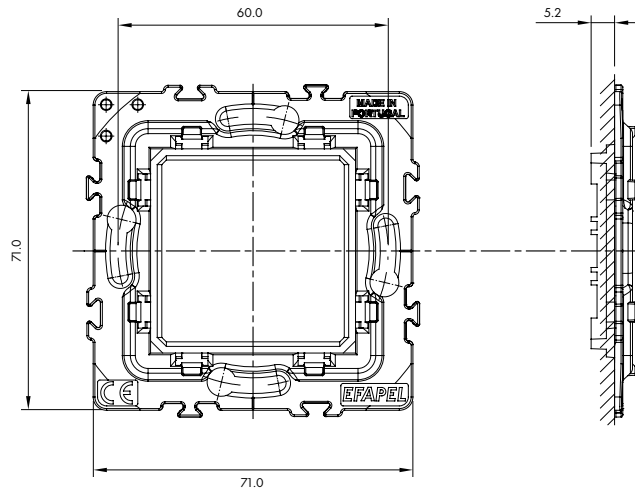

SINGLE WITH CLAWS

REF. 42994

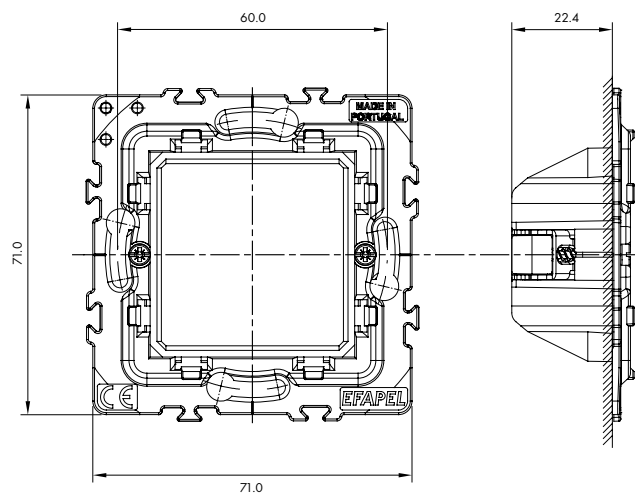

ITALIAN MATRIX SUPPORT FRAMES - DIMENSIONS (mm)

3 MODULES

REF. 41913 T (010) / 41914 T / 41915 T (101) / 41916 T (BASE, AQUARELLA, LYRA, LIGNA, METALLUM, CROMA AND CRYSTAL)

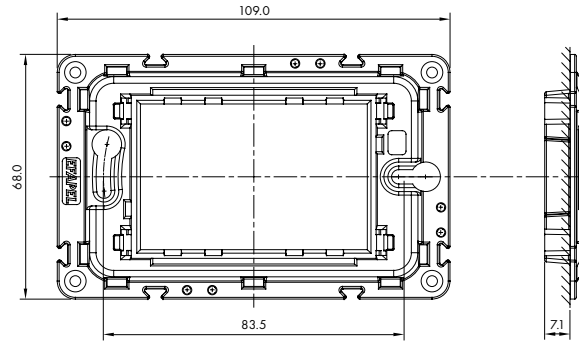

4 MODULES

REF. 41917 T (BASE, AQUARELLA, LYRA, LIGNA, METALLUM AND CROMA)

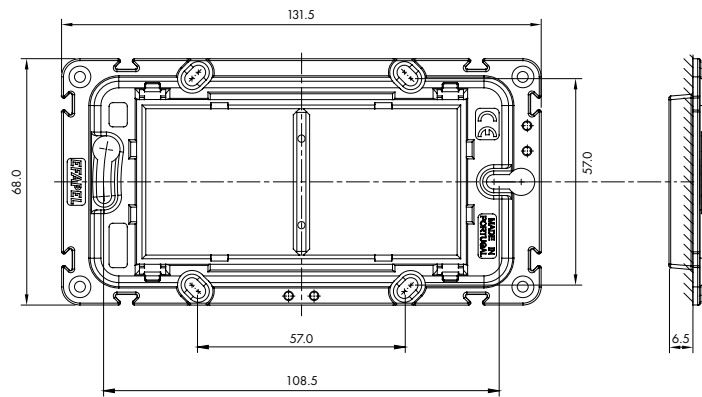

6 MODULES

REF. 41918 T (BASE, AQUARELLA, LYRA, LIGNA, AND METALLUM)

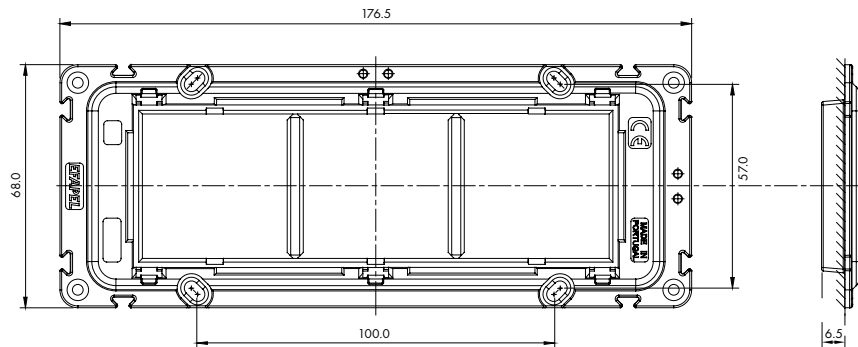

3+3 MODULES

REF. 41926 T (BASE, AQUARELLA, LYRA, LIGNA, METALLUM, CROMA AND CRYSTAL)

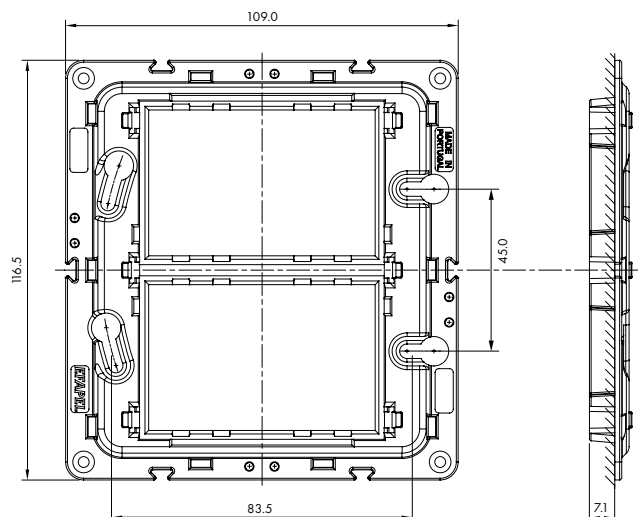

NOTES

**NOTES**

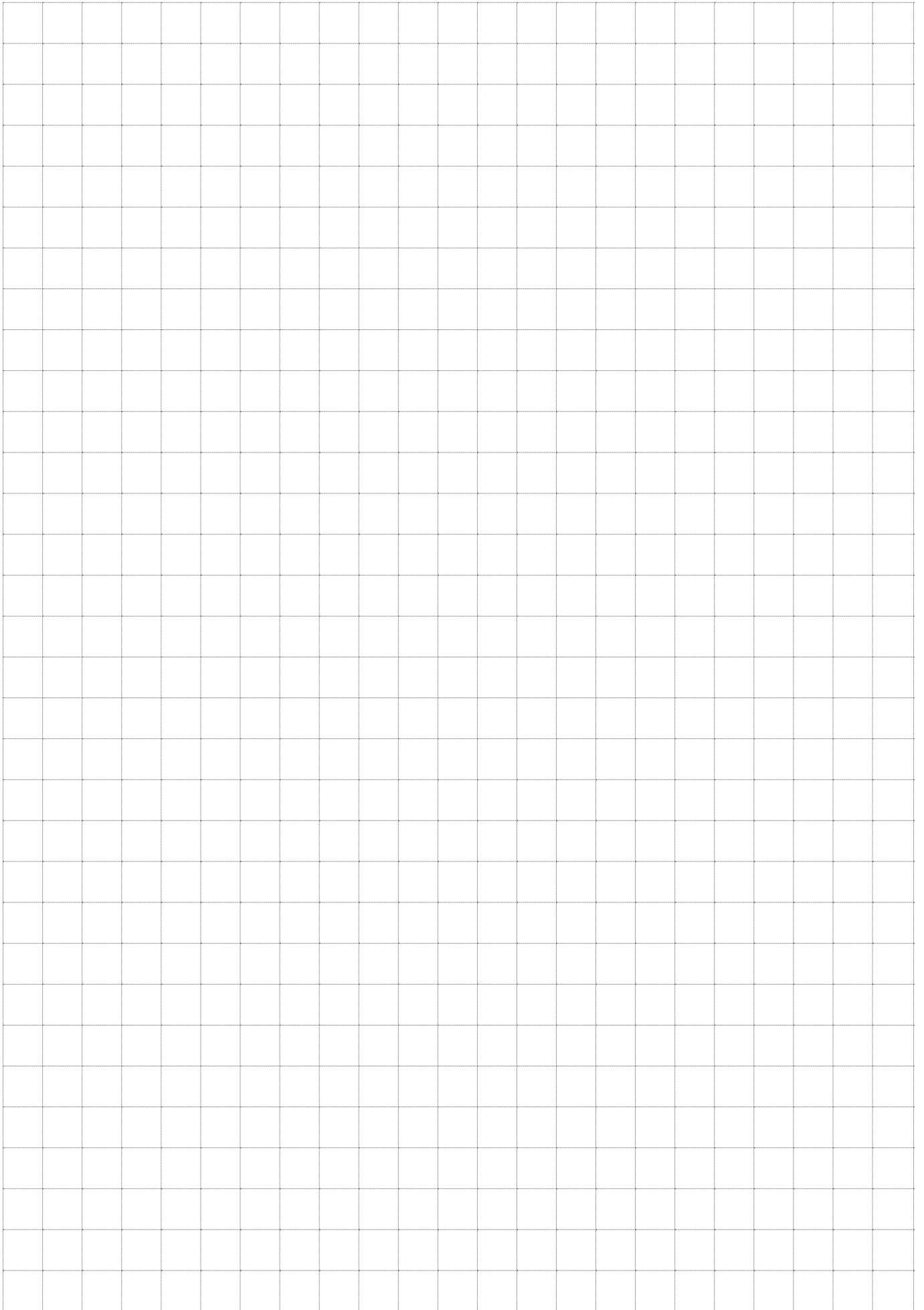





[efapel.com](http://efapel.com)



Distributor:

Serpins  
3200-355 Serpins  
PORTUGAL

EXPORT  
☎ +351 239 970 135  
✉ [export@efapel.com](mailto:export@efapel.com)

SAT - Technical Support Service  
☎ +351 239 970 132  
✉ [sat@efapel.com](mailto:sat@efapel.com)



EFAPEL reserves the right to amend this document or the products contained herein without prior notice. Please contact EFAPEL if you have any questions.